

**MEGA**  **TEC**

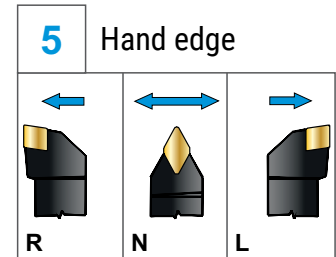

# TURNING TOOLHOLDERS

# TURNING TOOLHOLDERS, EXTERNAL

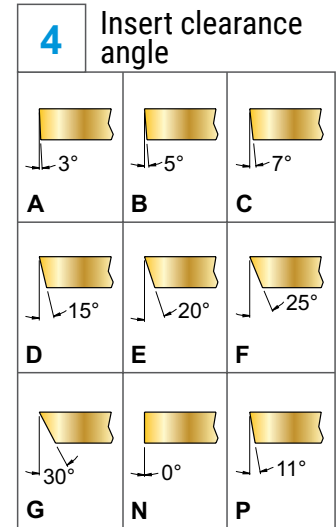
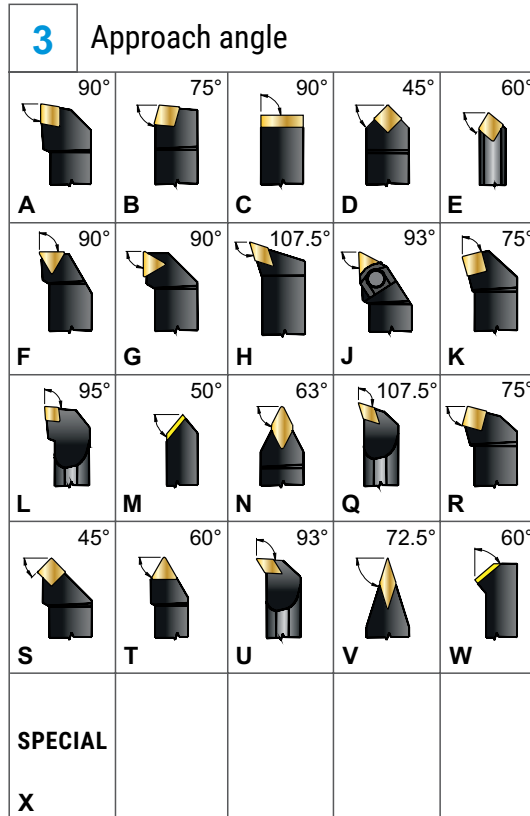
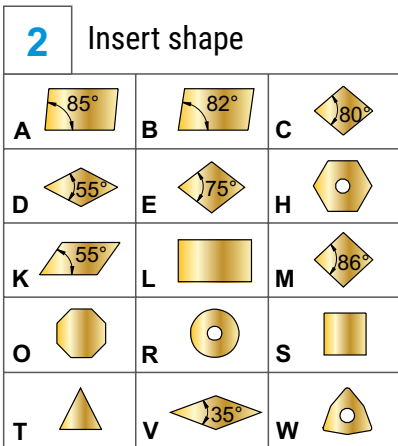
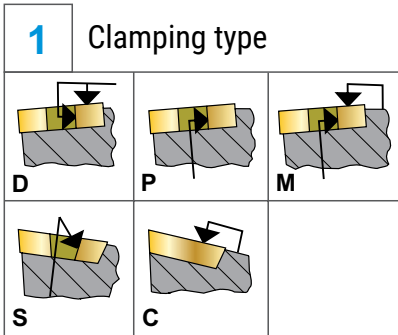

|          |          |          |          |          |           |           |          |           |
|----------|----------|----------|----------|----------|-----------|-----------|----------|-----------|
| <b>P</b> | <b>C</b> | <b>L</b> | <b>N</b> | <b>R</b> | <b>32</b> | <b>25</b> | <b>P</b> | <b>12</b> |
| 1        | 2        | 3        | 4        | 5        | 6         | 7         | 8        | 9         |

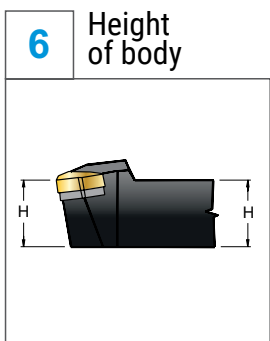

**8** Length of toolholder

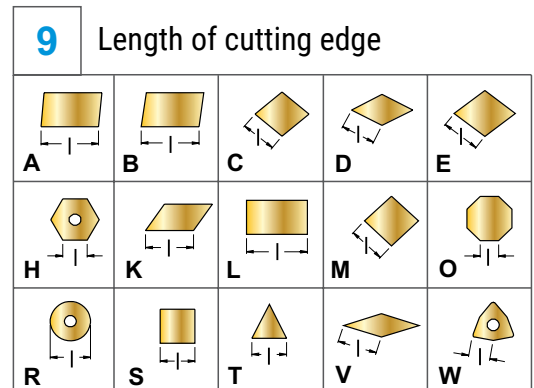
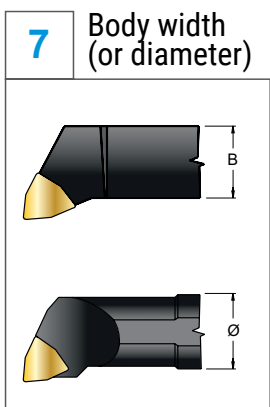

| L1 mm   | ISO |
|---------|-----|
| 32      | A   |
| 40      | B   |
| 50      | C   |
| 60      | D   |
| 70      | E   |
| 80      | F   |
| 90      | G   |
| 100     | H   |
| 110     | J   |
| 125     | K   |
| 140     | L   |
| 150     | M   |
| 160     | N   |
| 170     | P   |
| 180     | Q   |
| 200     | R   |
| 250     | S   |
| 300     | T   |
| 350     | U   |
| 400     | V   |
| 450     | W   |
| 500     | Y   |
| SPECIAL | X   |

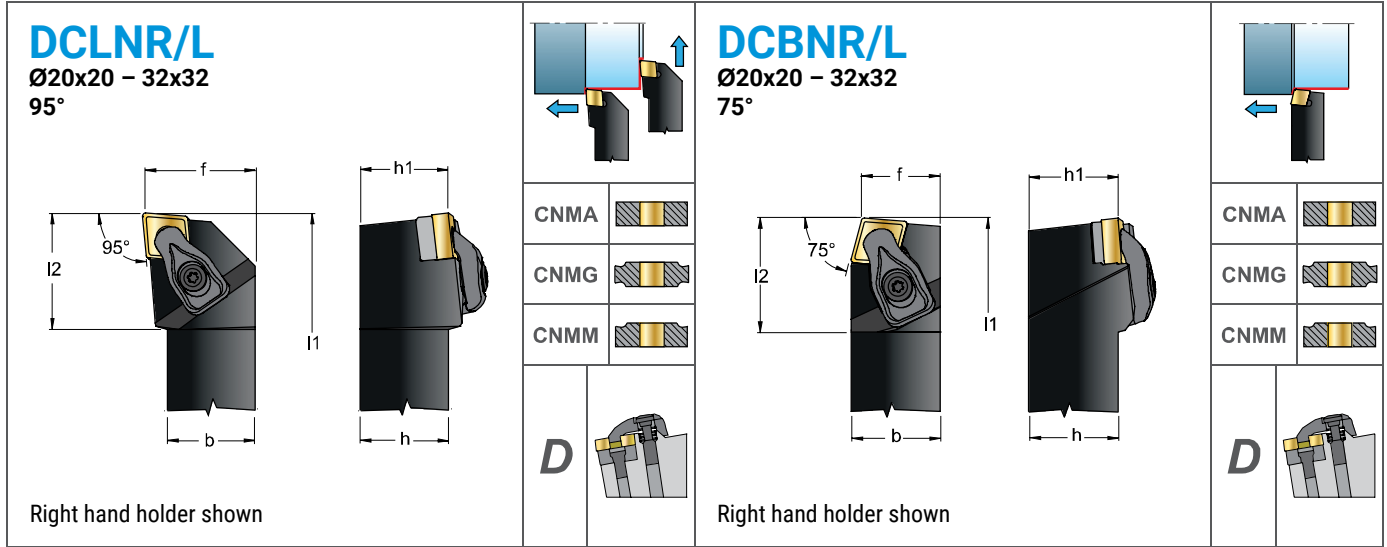

**10** Toolholder material

AH = HSS + through coolant  
 S = steel  
 A = steel + through coolant  
 E = solid carbide + through coolant



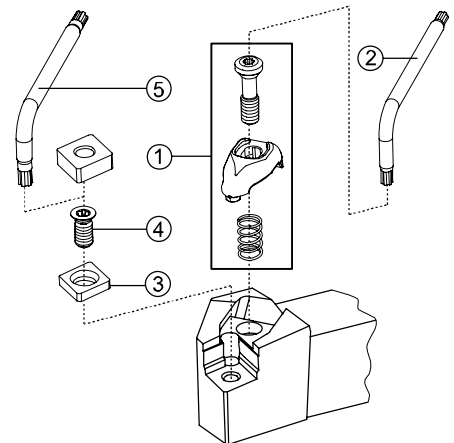

| Ordering Code |  |      | mm   |    |    |     |    |  |  | ①      | ②    | ③    | ④      | ⑤    |
|---------------|---|------|------|----|----|-----|----|---|---|--------|------|------|--------|------|
|               |   |      | h=h1 | b  | f  | l1  | l2 |   |   |        |      |      |        |      |
| DCLNR/L       | 2020  | K 12 | 20   | 20 | 25 | 125 | 30 | 3,9   |   |        |      |      |        |      |
| DCLNR/L       | 2525  | M 12 | 25   | 25 | 32 | 150 | 33 | 3,9   | 1204  | 100-21 | 5415 | 3612 | 125011 | 5420 |
| DCLNR/L       | 3232  | P 12 | 32   | 32 | 40 | 170 | 34 | 3,9   |   |        |      |      |        |      |
| DCLNR/L       | 2525  | M 16 | 25   | 25 | 32 | 150 | 36 | 6,4   |   |        |      |      |        |      |
| DCLNR/L       | 3232  | P 16 | 32   | 32 | 40 | 170 | 40 | 6,4   | 1606  | 100-31 | 5420 | 3616 | 126011 | 5425 |
|               |   |      |      |    |    |     |    |   |   |        |      |      |        |      |
| DCBNR/L       | 2020  | K 12 | 20   | 20 | 17 | 125 | 32 | 3,9   |   |        |      |      |        |      |
| DCBNR/L       | 2525  | M 12 | 25   | 25 | 22 | 150 | 32 | 3,9   | 1204  | 100-21 | 5415 | 3612 | 125011 | 5420 |
| DCBNR/L       | 3232  | P 12 | 32   | 32 | 27 | 170 | 32 | 3,9   |   |        |      |      |        |      |

Order example:  
Right hand DCLNR 2020K 12  
Left hand DCLNL 2020K 12

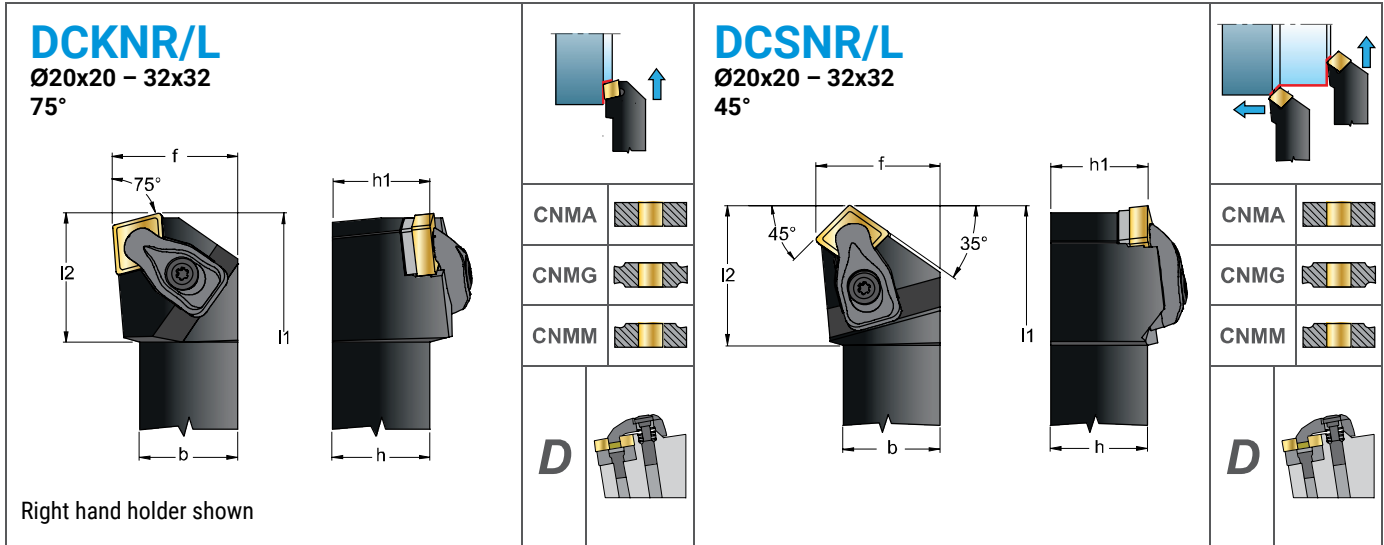



| Ordering Code     |  |  | mm   |    |    |     |    |  |  | ①      | ②    | ③    | ④      | ⑤    |
|-------------------|---|--|------|----|----|-----|----|---|---|--------|------|------|--------|------|
|                   |   |  | h=h1 | b  | f  | l1  | l2 |   |   |        |      |      |        |      |
| DCKNR/L 2020 K 12 |   |  | 20   | 20 | 25 | 125 | 30 | 3,9   |   |        |      |      |        |      |
| DCKNR/L 2525 M 12 |   |  | 25   | 25 | 32 | 150 | 33 | 3,9   | 1204  | 100-21 | 5415 | 3612 | 125011 | 5420 |
| DCKNR/L 3232 P 12 |   |  | 32   | 32 | 40 | 170 | 34 | 3,9   |   |        |      |      |        |      |
| DCSNR/L 2020 K 12 |   |  | 20   | 20 | 25 | 125 | 35 | 3,9   |   |        |      |      |        |      |
| DCSNR/L 2525 M 12 |   |  | 25   | 25 | 32 | 150 | 36 | 3,9   | 1204  | 100-21 | 5415 | 3612 | 125011 | 5420 |
| DCSNR/L 3232 P 12 |   |  | 32   | 32 | 40 | 170 | 40 | 3,9   |   |        |      |      |        |      |

Order example:  
Right hand DCKNR 2020 K 12  
Left hand DCKNL 2020 K 12

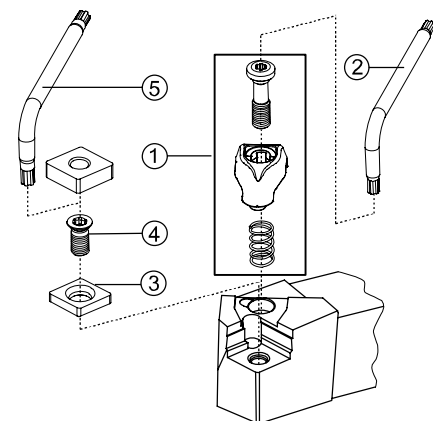

**DDJNR/L**  
Ø20x20 – 32x32  
93°

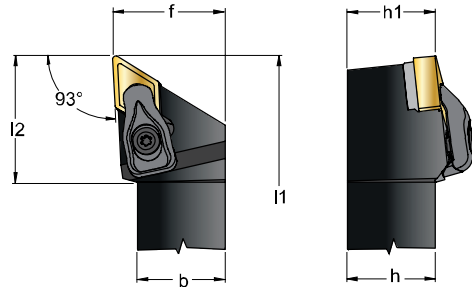



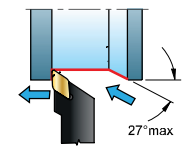



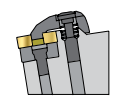

Right hand holder shown



**D**



| Ordering Code |  |      | mm   |    |    |     |    |  |  | ①  | ②  | ③  | ④  | ⑤  |
|---------------|---|------|------|----|----|-----|----|---|---|---|--|---|---|---|
|               |   |      | h=h1 | b  | f  | l1  | l2 |   |   |   |  |   |   |   |
| DDJNR/L       | 2020  | K 15 | 20   | 20 | 25 | 125 | 35 | 3,9   |   |   |  |   |   |   |
| DDJNR/L       | 2525  | M 15 | 25   | 25 | 32 | 150 | 36 | 3,9   | 1506  | 100-21  | 5415   | 3715  | 125011  | 5420  |
| DDJNR/L       | 3232  | P 15 | 32   | 32 | 40 | 170 | 40 | 3,9   |   |   |  |   |   |   |

Order example:  
Right hand DDJNR 2020 K 15  
Left hand DDJNL 2020 K 15

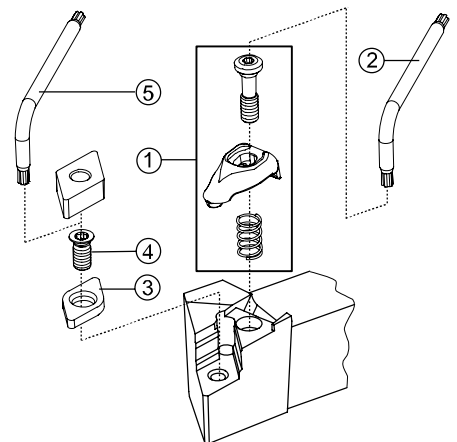



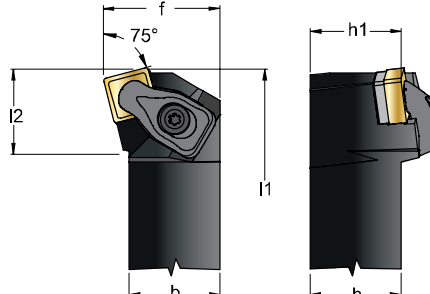

**DSKNR/L**  
Ø20x20 – 32x32  
75°

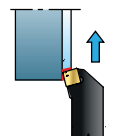

Right hand holder shown



|      |   |
|------|---|
| SNMA |  |
| SNMG |  |
| SNMM |  |

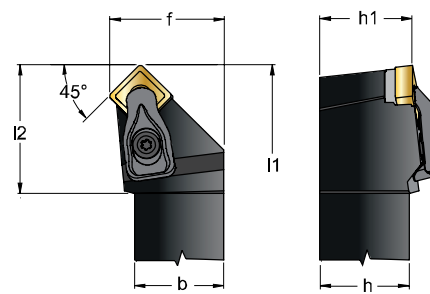

**D** 

**DSSNR/L**  
Ø20x20 – 25x25  
45°



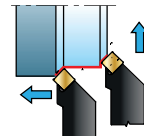





Right hand holder shown



|      |   |
|------|---|
| SNMA |  |
| SNMG |  |
| SNMM |  |

**D** 

| Ordering Code | R L  |      | mm |    |    |     |    | Nm  |  | ①  | ②  | ③  | ④  | ⑤  |
|---------------|------|------|----|----|----|-----|----|-----|---|---|---|---|---|---|
|               | h=h1 | b    | f  | l1 | l2 |     |    |     |   |   |   |   |   |   |
| DSKNR/L       | 2020 | K 12 | 20 | 20 | 25 | 125 | 30 | 3,9 |   |   |   |   |   |   |
| DSKNR/L       | 2525 | M 12 | 25 | 25 | 32 | 150 | 26 | 3,9 | 1204  | 100-21  | 5415  | 3512  | 125011  | 5420  |
| DSKNR/L       | 3232 | P 12 | 32 | 32 | 40 | 170 | 30 | 3,9 |   |   |   |   |   |   |
| DSKNR/L       | 3232 | P 15 | 32 | 32 | 40 | 170 | 30 | 6,4 | 1506  | 100-31  | 5420  | 3515  | 126011  | 5425  |
| DSSNR/L       | 2020 | K 12 | 20 | 20 | 25 | 125 | 35 | 3,9 |   |   |   |   |   |   |
| DSSNR/L       | 2525 | M 12 | 25 | 25 | 32 | 150 | 36 | 3,9 | 1204  | 100-21  | 5415  | 3512  | 125011  | 5420  |
| DSSNR/L       | 3232 | P 12 | 32 | 32 | 40 | 170 | 40 | 3,9 |   |   |   |   |   |   |

Order example:  
Right hand DSKNR 2020 K 12  
Left hand DSKNL 2020 K 12

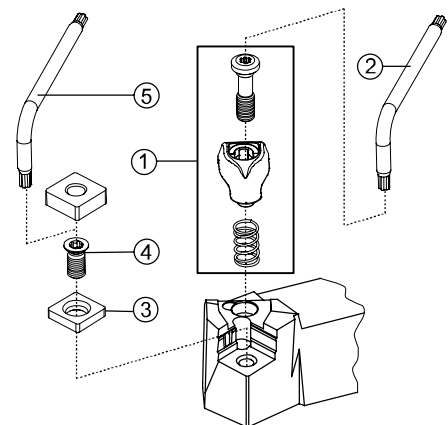

**DTJNR/L**  
Ø20x20 – 32x32  
93°

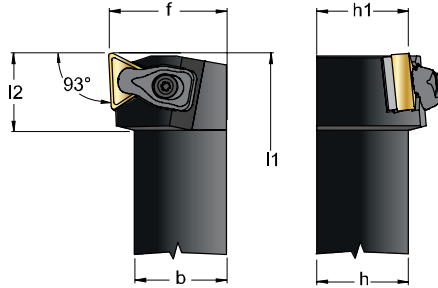



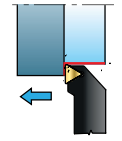



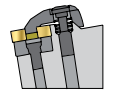

Right hand holder shown



**D**



| Ordering Code |  |   | mm   |    |    |    |     |  |  | ①  | ②  | ③  | ④  | ⑤  |
|---------------|---|---|------|----|----|----|-----|---|---|---|--|---|---|---|
|               |   |   | h=h1 | b  | f  | l1 | l2  |   |   |   |  |   |   |   |
| DTJNR/L       | 2020  | K | 16   | 20 | 20 | 25 | 125 | 20  | 1,8   |   |  |   |   |   |
| DTJNR/L       | 2525  | M | 16   | 25 | 25 | 32 | 150 | 21  | 1,8   | 1604  | 100-11   | 5409  | 3416  | 12409P 5515P  |
| DTJNR/L       | 3232  | P | 16   | 32 | 32 | 40 | 170 | 23  | 1,8   |   |  |   |   |   |

Order example:  
Right hand DTJNR 2020 K 16  
Left hand DTJNL 2020 K 16

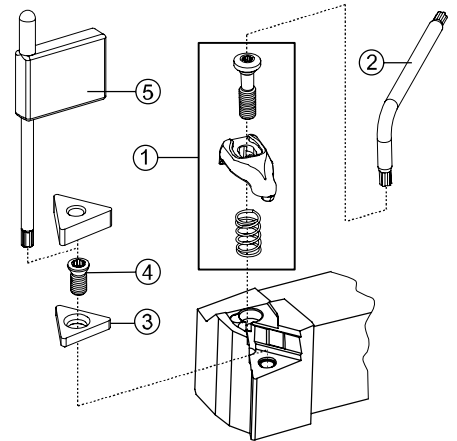

**DWLNRL/L**  
Ø20x20 – 25x25  
93°

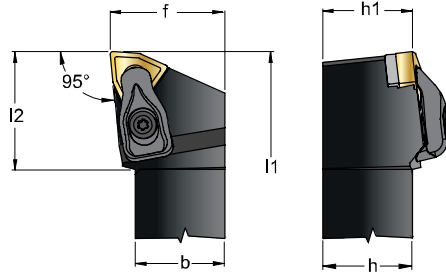



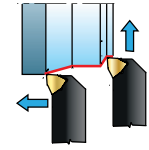



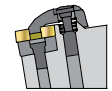

Right hand holder shown



**D**







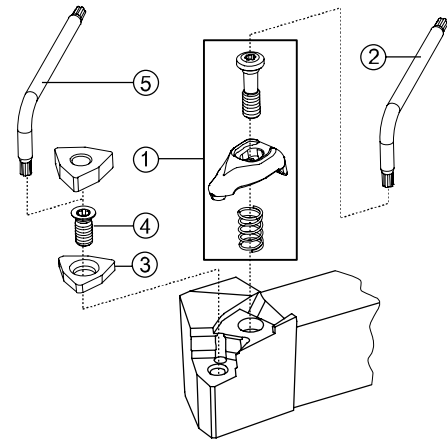

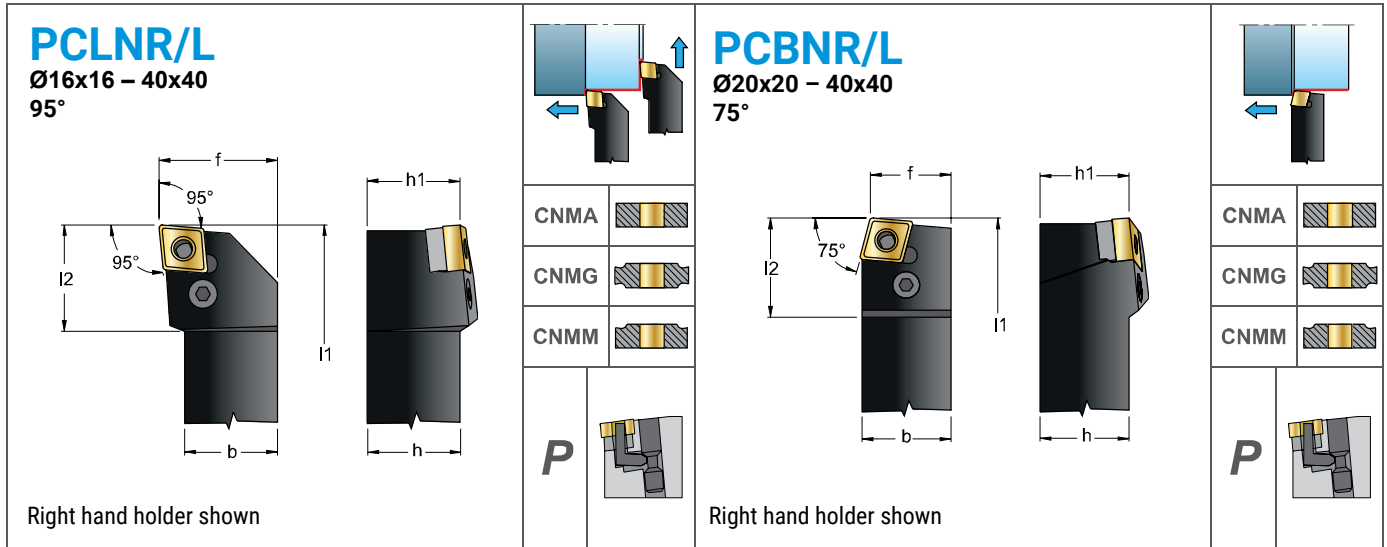

| Ordering Code |  |      | mm   |    |    |     |    |  Nm |  | ①  | ②  | ③  | ④  | ⑤  |
|---------------|---|------|------|----|----|-----|----|--|---|---|---|---|---|---|
|               |   |      | h=h1 | b  | f  | l1  | l2 |  |   |   |   |   |   |   |
| DWLNRL/L      | 2020  | K 08 | 20   | 20 | 25 | 125 | 30 | 3,9  | 0804  | 100-21  | 5415  | 3308M   | 125011  | 5420  |
| DWLNRL/L      | 2525  | M 08 | 25   | 25 | 32 | 150 | 33 | 3,9  |   |   |   |   |   |   |

**Order example:**  
Right hand DWLNR 2020 K 08  
Left hand DWLNL 2020 K 08











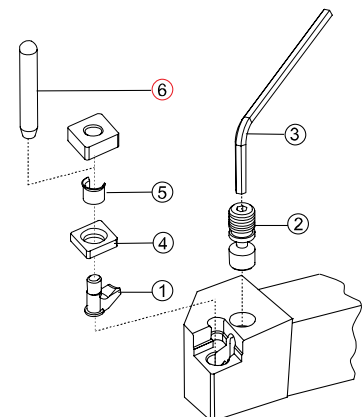

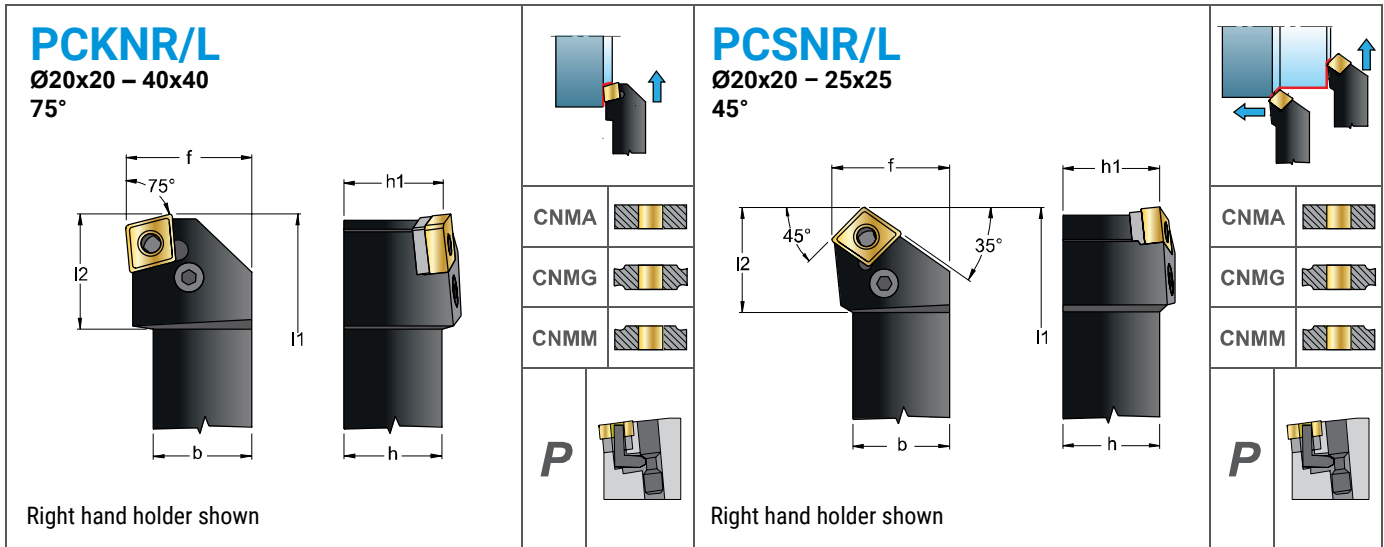

| Ordering Code     | R L  |    | mm |     |    |      |      |  |  |  |  |  |  |  |  |
|-------------------|------|----|----|-----|----|------|------|---|---|---|--|---|---|---|--|
|                   | h=h1 | b  | f  | l1  | l2 |      |      |   |   |   |  |   |   |   |  |
| PCLNR/L 1616 H 09 | 16   | 16 | 20 | 100 | 22 |      |      |   |   |   |  |   |   |   |  |
| PCLNR/L 2020 K 09 | 20   | 20 | 25 | 125 | 26 | 0903 | 8009 | 1606  | 5025  | 3608  | 4109   | 0009  |   |   |  |
| PCLNR/L 2525 M 09 | 25   | 25 | 32 | 150 | 25 |      |      |   |   |   |  |   |   |   |  |
| PCLNR/L 2020 K 12 | 20   | 20 | 25 | 125 | 28 |      |      |   |   |   |  |   |   |   |  |
| PCLNR/L 2525 M 12 | 25   | 25 | 32 | 150 | 33 | 1204 | 8012 | 1608  | 5003  | 3612  | 4112   | 0012  |   |   |  |
| PCLNR/L 3225 P 12 | 32   | 25 | 32 | 170 | 28 |      |      |   |   |   |  |   |   |   |  |
| PCLNR/L 3232 P 12 | 32   | 32 | 40 | 170 | 30 |      |      |   |   |   |  |   |   |   |  |
| PCLNR/L 2525 M 16 | 25   | 25 | 32 | 150 | 33 |      |      |   |   |   |  |   |   |   |  |
| PCLNR/L 3225 P 16 | 32   | 25 | 32 | 170 | 33 | 1606 | 8016 | 1618  | 5003  | 3616  | 4115   | 0015  |   |   |  |
| PCLNR/L 3232 P 16 | 32   | 32 | 40 | 170 | 33 |      |      |   |   |   |  |   |   |   |  |
| PCLNR/L 2525 M 19 | 25   | 25 | 32 | 150 | 36 |      |      |   |   |   |  |   |   |   |  |
| PCLNR/L 3232 P 19 | 32   | 32 | 40 | 170 | 40 | 1906 | 8019 | 1610  | 5004  | 3619  | 4119   | 0019  |   |   |  |
| PCLNR/L 4040 S 19 | 40   | 40 | 50 | 250 | 40 |      |      |   |   |   |  |   |   |   |  |
| PCLNR/L 4040 S 25 | 40   | 40 | 50 | 250 | -  | 2509 | LV25 | V1225   | S1225   | S8025N  | CBR50  |   |   |   |  |
| PCLNR/L 5050 T 25 | 50   | 50 | 60 | 300 | -  | 2509 | LV25 | V1225   | S1225   | S8025N  | CBR50  |   |   |   |  |
| PCBNR/L 2020 K 12 | 20   | 20 | 17 | 125 | 28 |      |      |   |   |   |  |   |   |   |  |
| PCBNR/L 2525 M 12 | 25   | 25 | 22 | 150 | 29 | 1204 | 8012 | 1608  | 5003  | 3612  | 4112   | 0012  |   |   |  |
| PCBNR/L 3225 P 12 | 32   | 25 | 22 | 170 | 32 |      |      |   |   |   |  |   |   |   |  |
| PCBNR/L 2525 M 16 | 25   | 25 | 22 | 150 | 29 |      |      |   |   |   |  |   |   |   |  |
| PCBNR/L 3225 P 16 | 32   | 25 | 22 | 170 | 32 | 1606 | 8016 | 1618  | 5003  | 3616  | 4115   | 0015  |   |   |  |
| PCBNR/L 3232 P 16 | 32   | 32 | 27 | 170 | 35 |      |      |   |   |   |  |   |   |   |  |
| PCBNR/L 3232 P 19 | 32   | 32 | 27 | 170 | 35 |      |      |   |   |   |  |   |   |   |  |
| PCBNR/L 4040 S 19 | 40   | 40 | 35 | 250 | 37 | 1906 | 8019 | 1610  | 5004  | 3619  | 4119   | 0019  |   |   |  |
| PCBNR/L 4040 S 25 | 40   | 40 | 50 | 250 | -  | 2509 | LV25 | V1225   | S1225   | S8025N  | CBR50  |   |   |   |  |
| PCBNR/L 5050 T 25 | 50   | 50 | 60 | 300 | -  | 2509 | LV25 | V1225   | S1225   | S8025N  | CBR50  |   |   |   |  |

Order example:  
Right hand PCLNR 1616 H 09  
Left hand PCLNL 1616 H 09









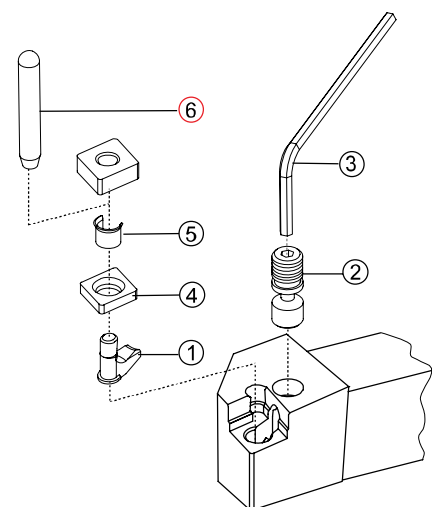

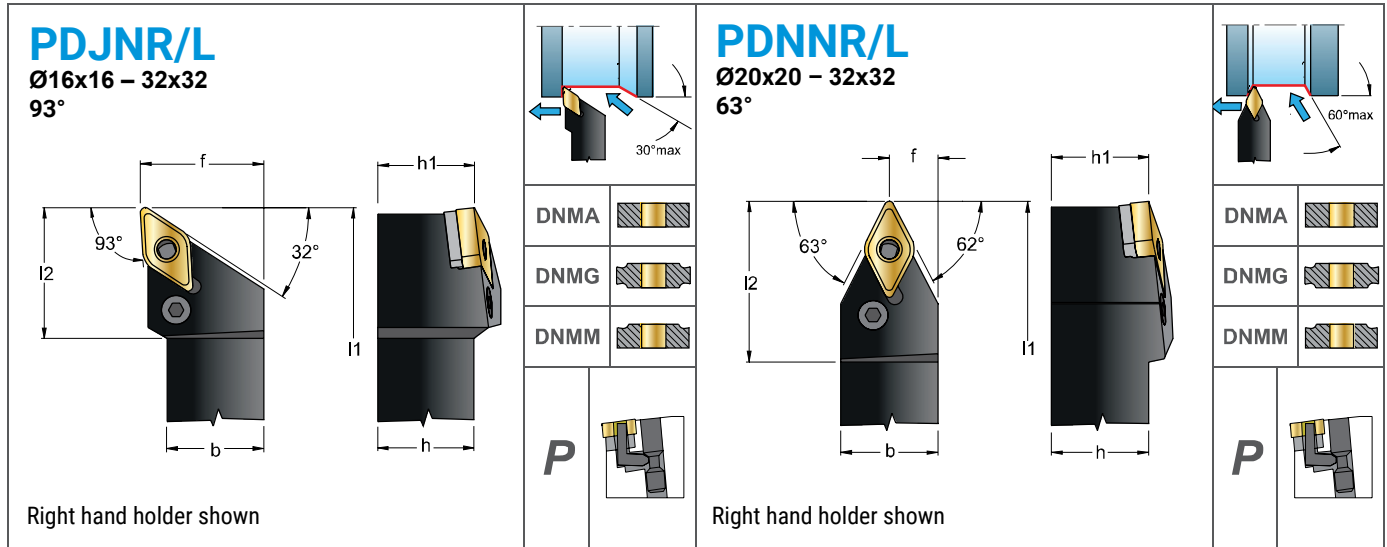

| Ordering Code |  |   | mm   |    |    |    |     |  |  |  |  |  |  |  |      |
|---------------|---|---|------|----|----|----|-----|---|---|---|---|---|---|---|------|
|               |   |   | h=h1 | b  | f  | l1 | l2  |   |   |   |   |   |   |   |      |
| PCKNR/L       | 2020  | K | 12   | 20 | 20 | 25 | 125 | 26  | 1204  | 8012  | 1608  | 5003  | 3612  | 4112  | 0012 |
| PCKNR/L       | 2525  | M | 12   | 25 | 25 | 32 | 150 | 30  |   |   |   |   |   |   |      |
| PCKNR/L       | 2525  | M | 16   | 25 | 25 | 32 | 150 | 33  |   |   |   |   |   |   |      |
| PCKNR/L       | 3232  | P | 16   | 32 | 32 | 40 | 170 | 34  |   |   |   |   |   |   |      |
| PCKNR/L       | 3232  | P | 19   | 32 | 32 | 40 | 170 | 36  |   |   |   |   |   |   |      |
| PCKNR/L       | 4040  | S | 19   | 40 | 40 | 50 | 250 | 45  |   |   |   |   |   |   |      |
| PCKNR/L       | 2020  | K | 12   | 20 | 20 | 25 | 125 | 28  | 1204  | 8012  | 1608  | 5003  | 3612  | 4112  | 0012 |
| PCKNR/L       | 2525  | M | 12   | 25 | 25 | 32 | 150 | 30  |   |   |   |   |   |   |      |

Order example:  
Right hand PCKNR 2020 K 12  
Left hand PCKNL 2020 K 12









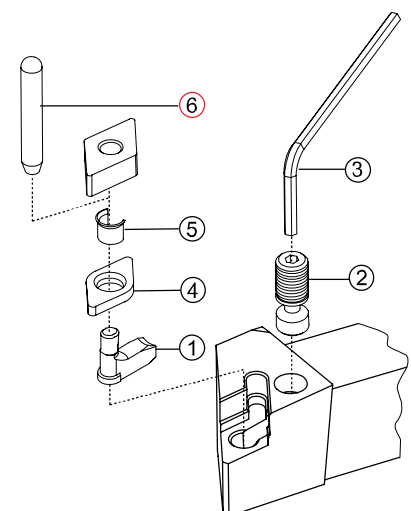

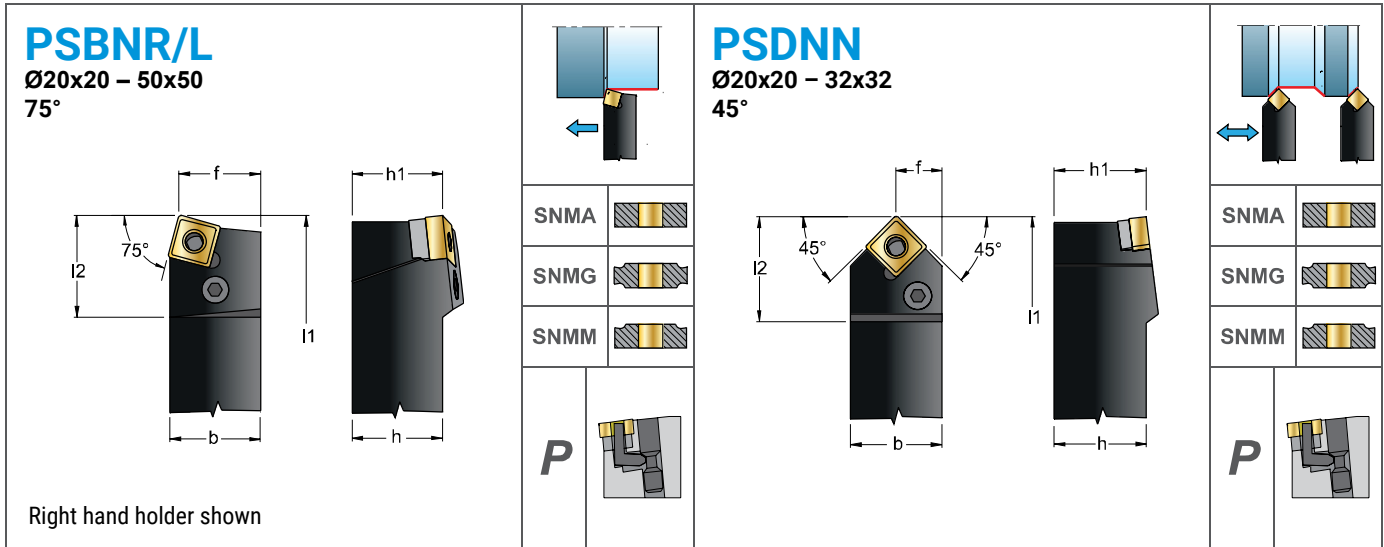

























| Ordering Code |  |      | mm   |    |      |     |    |  |  |  |  |  |  |  |
|---------------|---|------|------|----|------|-----|----|---|---|---|--|---|---|---|
|               |   |      | h=h1 | b  | f    | l1  | l2 |   |   |   |  |   |   |   |
| PDJNR/L       | 1616  | H 11 | 16   | 16 | 20   | 100 | 30 |   |   |   |  |   |   |   |
| PDJNR/L       | 2020  | K 11 | 20   | 20 | 25   | 125 | 30 | 1104  | 8411  | 1606  | 5025   | 3710  | 4108  | 0009  |
| PDJNR/L       | 2525  | M 11 | 25   | 25 | 32   | 150 | 30 |   |   |   |  |   |   |   |
| PDJNR/L       | 2020  | K 15 | 20   | 20 | 25   | 125 | 35 |   |   |   |  |   |   |   |
| PDJNR/L       | 2525  | M 15 | 25   | 25 | 32   | 150 | 35 | 1506  | 8415  | 1638  | 5003   | 3715  | 4112  | 0012  |
| PDJNR/L       | 3225  | P 15 | 32   | 25 | 32   | 170 | 35 |   |   |   |  |   |   |   |
| PDJNR/L       | 3232  | P 15 | 32   | 32 | 40   | 170 | 36 |   |   |   |  |   |   |   |
| PDNNR/L       | 2020  | K 15 | 20   | 20 | 12,0 | 125 | 35 |   |   |   |  |   |   |   |
| PDNNR/L       | 2525  | M 15 | 25   | 25 | 12,0 | 150 | 37 |   |   |   |  |   |   |   |
| PDNNR/L       | 3225  | P 15 | 32   | 25 | 12,0 | 170 | 37 | 1506  | 8415  | 1638  | 5003   | 3715  | 4112  | 0012  |
| PDNNR/L       | 3232  | P 15 | 32   | 32 | 16,8 | 170 | 37 |   |   |   |  |   |   |   |

Order example:  
Right hand PDJNR 1616 H 11  
Left hand PDJNL 1616 H 11











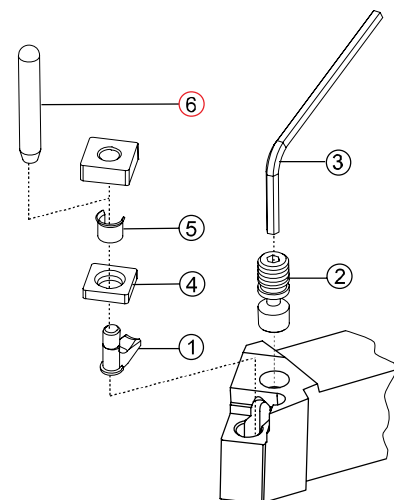

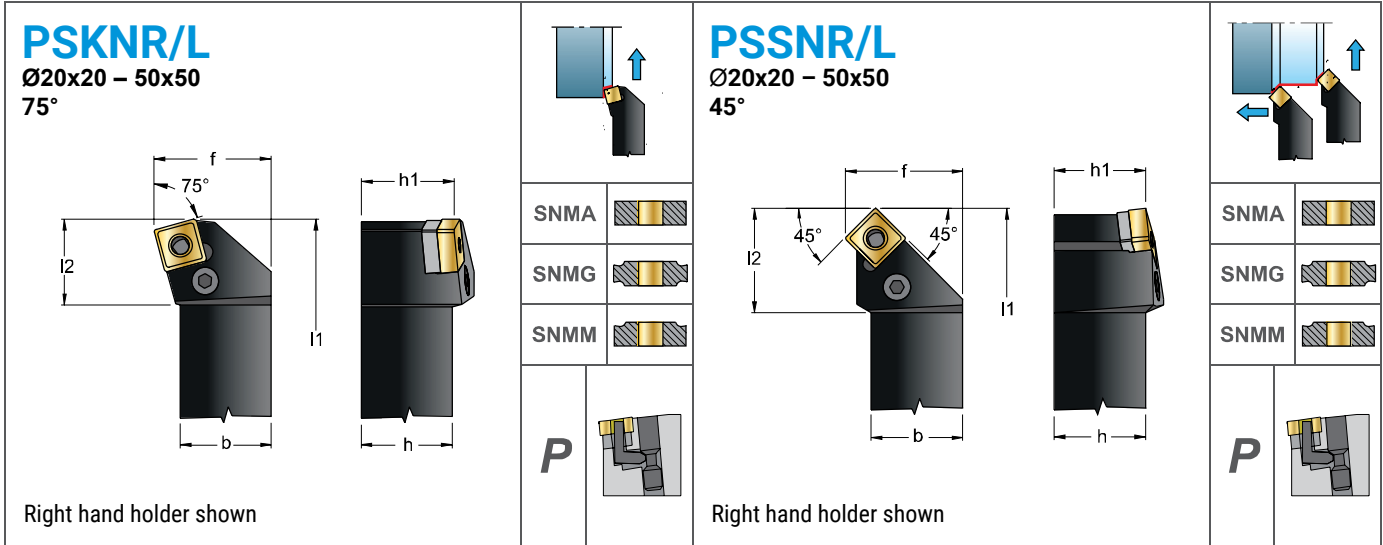
| Ordering Code     |  |    | mm   |     |    |      |   |  |  |    |    |  |  |  |      |      |      |      |
|-------------------|---|----|------|-----|----|------|---|---|---|---|---|---|---|---|------|------|------|------|
|                   |   |    | h=h1 | b   | f  | l1   | l2  |   |   |   |   |   |   |   |      |      |      |      |
| PSBNR/L 2020 K 12 | 20  | 20 | 17   | 125 | 28 | 1204 |  |  |  |  |  |  | 8012  | 1608  | 5003 | 3512 | 4112 | 0012 |
| PSBNR/L 2525 M 12 | 25  | 25 | 22   | 150 | 29 |      |   |   |   |   |   |   |   |   |      |      |      |      |
| PSBNR/L 2525 M 15 | 25  | 25 | 22   | 150 | 32 | 1506 |  |  |  |  |  |  | 8016  | 1618  | 5003 | 3515 | 4115 | 0015 |
| PSBNR/L 3232 P 15 | 32  | 32 | 27   | 170 | 32 |      |   |   |   |   |   |   |   |   |      |      |      |      |
| PSBNR/L 3232 P 19 | 32  | 32 | 27   | 170 | 39 | 1906 |  |  |  |  |  |  | 8019  | 1610  | 5004 | 3519 | 4119 | 0019 |
| PSBNR/L 4040 S 19 | 40  | 40 | 35   | 250 | 39 |      |   |   |   |   |   |   |   |   |      |      |      |      |
| PSBNR/L 4040 S 25 | 40  | 40 | 50   | 250 | -  | 2509 | LV25  | V1225   | S1225   | S9025N  | CBR50   |   |   |   |      |      |      |      |
| PSBNR/L 5050 T 25 | 50  | 50 | 60   | 300 | -  | 2509 | LV25  | V1225   | S1225   | S9025N  | CBR50   |   |   |   |      |      |      |      |

|                 |    |    |      |     |    |      |   |   |   |   |   |   |      |      |      |      |      |      |
|-----------------|----|----|------|-----|----|------|---|---|---|---|---|---|------|------|------|------|------|------|
| PSDNN 2020 K 12 | 20 | 20 | 10,3 | 125 | 28 | 1204 |  |  |  |  |  |  | 8012 | 1608 | 5003 | 3512 | 4112 | 0012 |
| PSDNN 2525 M 12 | 25 | 25 | 12,8 | 150 | 29 |      |   |   |   |   |   |   |      |      |      |      |      |      |
| PSDNN 3232 P 19 | 32 | 32 | 16,5 | 170 | 40 | 1906 | 8019  | 1610  | 5004  | 3519  | 4119  | 0019  |      |      |      |      |      |      |

Order example:  
Right hand PSBNR 2020 K 12  
Left hand PSBNL 2020 K 12





| Ordering Code     |  |    | mm   |     |    |      |      |       |  | ①  | ②  | ③  | ④  | ⑤  | ⑥  |
|-------------------|---|----|------|-----|----|------|------|-------|---|---|---|--|---|---|---|
|                   |   |    | h=h1 | b   | f  | l1   | l2   |       |   |   |   |  |   |   |   |
| PSKNR/L 2020 K 12 | 20  | 20 | 25   | 125 | 26 | 1204 | 8012 | 1608  | 5003  | 3512  | 4112  | 0012   |   |   |   |
| PSKNR/L 2525 M 12 | 25  | 25 | 32   | 150 | 26 | 1506 | 8016 | 1618  | 5003  | 3515  | 4115  | 0015   |   |   |   |
| PSKNR/L 2525 M 15 | 25  | 25 | 32   | 150 | 30 | 1906 | 8019 | 1610  | 5004  | 3519  | 4119  | 0019   |   |   |   |
| PSKNR/L 3232 P 15 | 32  | 32 | 40   | 170 | 30 | 2509 | LV25 | V1225 | S1225   | S9025N  | CBR50   |  |   |   |   |
| PSKNR/L 3232 P 19 | 32  | 32 | 40   | 170 | 34 | 2509 | LV25 | V1225 | S1225   | S9025N  | CBR50   |  |   |   |   |
| PSKNR/L 4040 S 19 | 40  | 40 | 50   | 250 | 38 |      |      |       |   |   |   |  |   |   |   |
| PSKNR/L 4040 S 25 | 40  | 40 | 50   | 250 | -  |      |      |       |   |   |   |  |   |   |   |
| PSKNR/L 5050 T 25 | 50  | 50 | 60   | 300 | -  |      |      |       |   |   |   |  |   |   |   |

|                   |    |    |    |     |    |      |      |      |      |      |      |      |
|-------------------|----|----|----|-----|----|------|------|------|------|------|------|------|
| PSSNR/L 2020 K 12 | 20 | 20 | 25 | 125 | 29 | 1204 | 8012 | 1608 | 5003 | 3512 | 4112 | 0012 |
| PSSNR/L 2525 M 12 | 25 | 25 | 32 | 150 | 29 | 1506 | 8016 | 1618 | 5003 | 3515 | 4115 | 0015 |
| PSSNR/L 3225 P 12 | 32 | 25 | 32 | 170 | 29 | 1906 | 8019 | 1610 | 5004 | 3519 | 4119 | 0019 |
| PSSNR/L 2525 M 15 | 25 | 25 | 32 | 150 | 36 |      |      |      |      |      |      |      |
| PSSNR/L 3232 P 15 | 32 | 32 | 40 | 170 | 36 |      |      |      |      |      |      |      |
| PSSNR/L 3232 P 19 | 32 | 32 | 40 | 170 | 40 |      |      |      |      |      |      |      |
| PSSNR/L 4040 S 19 | 40 | 40 | 50 | 250 | 40 |      |      |      |      |      |      |      |
| PSSNR/L 4040 S 25 | 40 | 40 | 50 | 250 | -  |      |      |      |      |      |      |      |
| PSSNR/L 5050 T 25 | 50 | 50 | 50 | 300 | -  |      |      |      |      |      |      |      |

Order example:  
Right hand PSKNR 2020 K 12  
Left hand PSKNL 2020 K 12

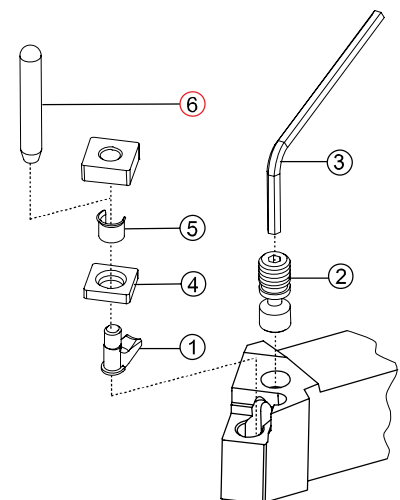

### PTFNR/L

Ø20x20 – 32x32  
90°

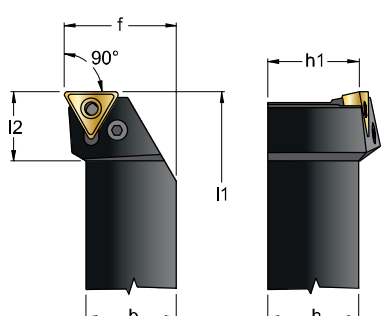

Right hand holder shown

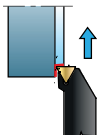

### PTGNR/L

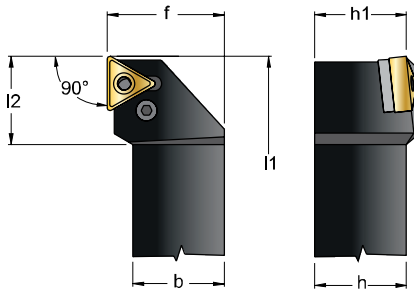

Ø20x20 – 32x32  
90°

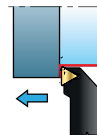

Right hand holder shown



|      |  |  |  |  |  |  |  |  |  |  |  |  |  |  |  |  |  |  |  |  |
|------|--|--|--|--|--|--|--|--|--|--|--|--|--|--|--|--|--|--|--|--|
|      |  |  |  |  |  |  |  |  |  |  |  |  |  |  |  |  |  |  |  |  |
| TNMA |  |  |  |  |  |  |  |  |  |  |  |  |  |  |  |  |  |  |  |  |
| TNMG |  |  |  |  |  |  |  |  |  |  |  |  |  |  |  |  |  |  |  |  |
| TNMM |  |  |  |  |  |  |  |  |  |  |  |  |  |  |  |  |  |  |  |  |
| P    |  |  |  |  |  |  |  |  |  |  |  |  |  |  |  |  |  |  |  |  |

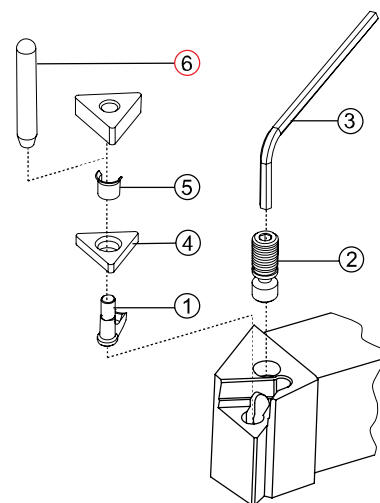

| Ordering Code |  |   | mm   |    |    |    |     |  | ①    | ②    | ③    | ④    | ⑤    | ⑥    |      |      |      |      |      |      |      |      |
|---------------|---|---|------|----|----|----|-----|---|------|------|------|------|------|------|------|------|------|------|------|------|------|------|
|               |   |   | h=h1 | b  | f  | l1 | l2  |   |      |      |      |      |      |      |      |      |      |      |      |      |      |      |
| PTFNR/L       | 2020  | K | 16   | 20 | 20 | 25 | 125 | 20  | 1604 | 8009 | 1606 | 5025 | 3416 | 4109 | 0009 |      |      |      |      |      |      |      |
| PTFNR/L       | 2525  | M | 16   | 25 | 25 | 32 | 150 | 21  |      |      |      |      |      |      |      |      |      |      |      |      |      |      |
| PTFNR/L       | 2525  | M | 22   | 25 | 25 | 32 | 150 | 27  |      |      |      |      |      |      |      |      |      |      |      |      |      |      |
| PTFNR/L       | 3225  | P | 22   | 32 | 25 | 32 | 170 | 25  |      |      |      |      |      |      |      | 2204 | 8012 | 1608 | 5003 | 3422 | 4112 | 0012 |
| PTFNR/L       | 3232  | P | 22   | 32 | 32 | 40 | 170 | 25  |      |      |      |      |      |      |      |      |      |      |      |      |      |      |
| PTGNR/L       | 2020  | K | 16   | 20 | 20 | 25 | 125 | 20  | 1604 | 8009 | 1606 | 5025 | 3416 | 4109 | 0009 |      |      |      |      |      |      |      |
| PTGNR/L       | 2525  | M | 16   | 25 | 25 | 32 | 150 | 21  |      |      |      |      |      |      |      |      |      |      |      |      |      |      |
| PTGNR/L       | 2525  | M | 22   | 25 | 25 | 32 | 150 | 27  |      |      |      |      |      |      |      |      |      |      |      |      |      |      |
| PTGNR/L       | 3225  | P | 22   | 32 | 25 | 32 | 170 | 29  |      |      |      |      |      |      |      | 2204 | 8012 | 1608 | 5003 | 3422 | 4112 | 0012 |
| PTGNR/L       | 3232  | P | 22   | 32 | 32 | 40 | 170 | 29  |      |      |      |      |      |      |      |      |      |      |      |      |      |      |

**Order example:**  
Right hand PTFNR 2020 K 16  
Left hand PTFNL 2020 K 16

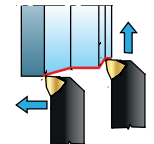
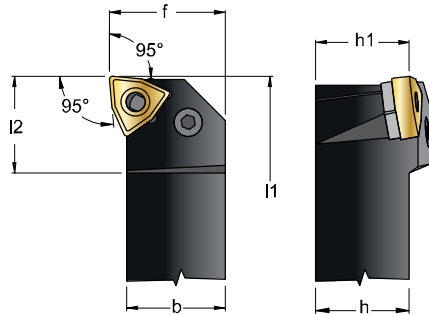

**PWLNLR/L**  
Ø16x16 – 32x32  
95°







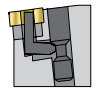



|       |   |
|-------|---|
| WNMA  |  |
| WNUMG |  |
| WNMM  |  |

**P**









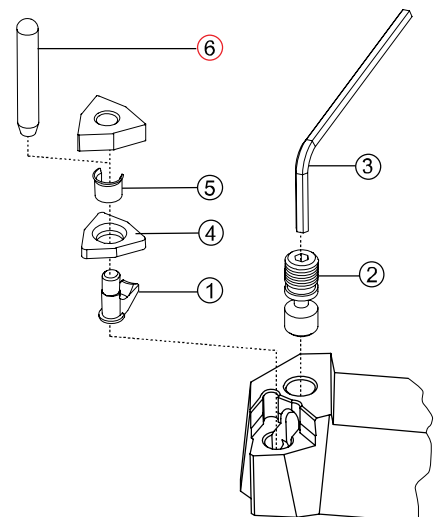

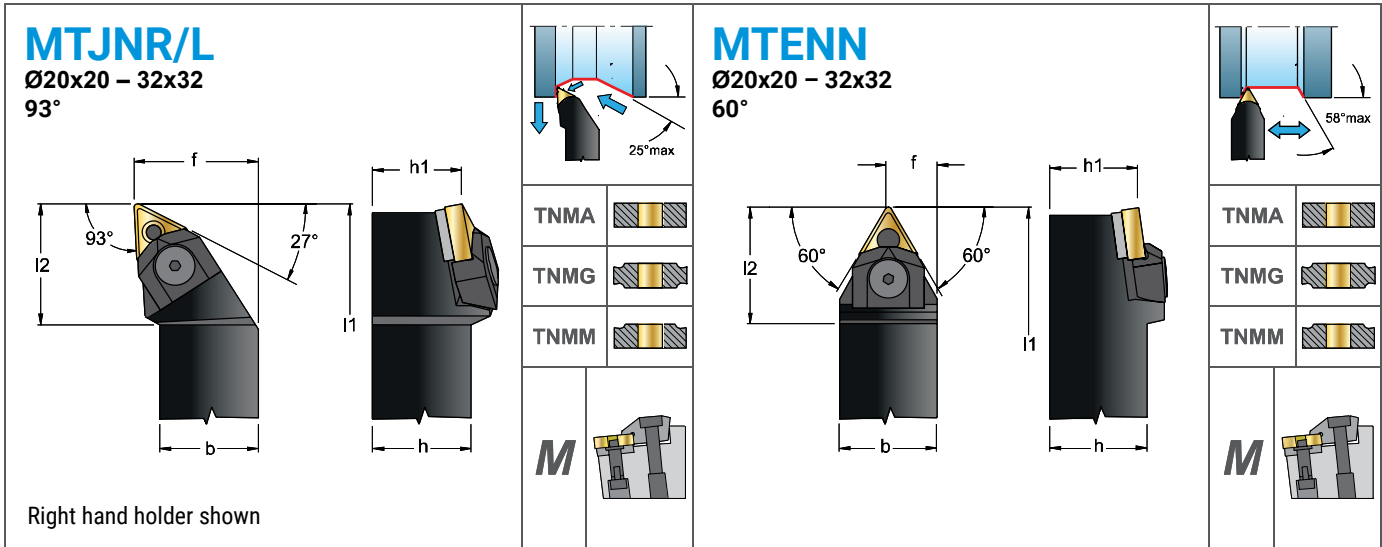
Right hand holder shown

| Ordering Code      |  | mm   |    |    |     |    |  |  |  |  |  |  |  |
|--------------------|---|------|----|----|-----|----|---|---|---|---|---|---|---|
|                    |   | h=h1 | b  | f  | l1  | l2 |   |   |   |   |   |   |   |
| PWLNLR/L 1616 H 06 |   | 16   | 16 | 20 | 100 | 16 |   |   |   |   |   |   |   |
| PWLNLR/L 2020 K 06 |   | 20   | 20 | 25 | 125 | 16 | 0604  | 8009  | 1606  | 5025  | 3306  | 4109  | 0009  |
| PWLNLR/L 2525 M 06 |   | 25   | 25 | 32 | 150 | 16 |   |   |   |   |   |   |   |
| PWLNLR/L 2020 K 08 |   | 20   | 20 | 25 | 125 | 20 |   |   |   |   |   |   |   |
| PWLNLR/L 2525 M 08 |   | 25   | 25 | 32 | 150 | 21 |   |   |   |   |   |   |   |
| PWLNLR/L 3225 P 08 |   | 32   | 25 | 32 | 170 | 23 | 0804  | 8012  | 1608  | 5003  | 3308M   | 4112  | 0012  |
| PWLNLR/L 3232 P 08 |   | 32   | 32 | 40 | 170 | 23 |   |   |   |   |   |   |   |

Order example:  
Right hand PWLNLR 1616 H 06  
Left hand PWLNLR 1616 H 06





| Ordering Code | R L  |      | mm |    |      |     |    |  | ①  | ②  | ③  | ④  | ⑤  | ⑥  |  |
|---------------|------|------|----|----|------|-----|----|---|---|---|---|---|---|---|--|
|               | h=h1 | b    | f  | l1 | l2   |     |    |   |   |   |   |   |   |   |  |
| MTJNR/L       | 2020 | K 16 | 20 | 20 | 25   | 125 | 31 |   |   |   |   |   |   |   |  |
| MTJNR/L       | 2525 | M 16 | 25 | 25 | 32   | 150 | 36 | 1604  | 100-50  | 5025  | 3216  | 4186  | 4196  | 5003  |  |
| MTJNR/L       | 3225 | P 16 | 32 | 25 | 32   | 170 | 35 |   |   |   |   |   |   |   |  |
| MTJNR/L       | 2525 | M 22 | 25 | 25 | 32   | 150 | 36 |   |   |   |   |   |   |   |  |
| MTJNR/L       | 3225 | P 22 | 32 | 25 | 32   | 170 | 35 | 2204  | 100-51  | 5003  | 3222  | 4192  | 4196  | -   |  |
| MTJNR/L       | 3232 | P 22 | 32 | 32 | 40   | 170 | 36 |   |   |   |   |   |   |   |  |
| MTENN         | 2020 | K 16 | 20 | 20 | 10,5 | 125 | 35 | 1604  | 100-50  | 5025  | 3216  | 4186  | 4196  | 5003  |  |
| MTENN         | 2525 | M 16 | 25 | 25 | 13,0 | 150 | 37 |   |   |   |   |   |   |   |  |
| MTENN         | 2525 | M 22 | 25 | 25 | 13,0 | 150 | 37 |   |   |   |   |   |   |   |  |
| MTENN         | 3232 | P 22 | 32 | 32 | 16,5 | 170 | 37 | 2204  | 100-51  | 5003  | 3222  | 4192  | 4196  | -   |  |

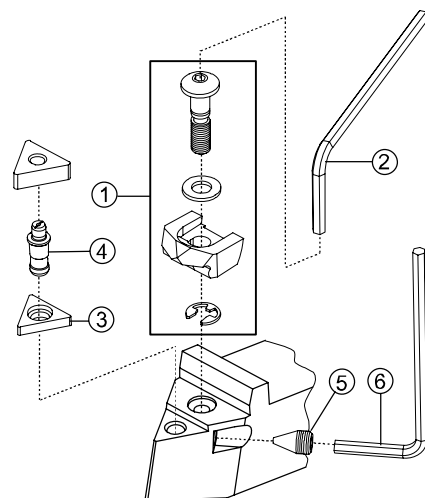

Order example:  
Right hand MTJNR 2020 K 16  
Left hand MTJNL 2020 K 16  
Нейтральное исполнение MTENN 2020 K 16



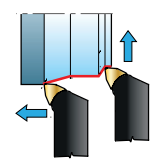
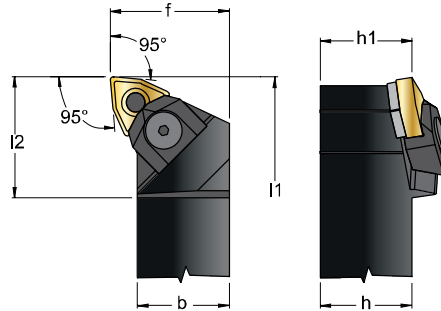

**MWLNR/L**  
Ø20x20 – 32x32  
95°



|      |   |
|------|---|
| WNMA |  |
| WNMG |  |
| WNMM |  |

**M**

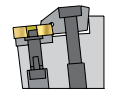

Right hand holder shown

| Ordering Code      | R L  |   | mm |    |    |     |    |  | ①      | ②    | ③    | ④     | ⑤    | ⑥      | ⑦    |
|--------------------|------|---|----|----|----|-----|----|---|--------|------|------|-------|------|--------|------|
|                    | h=h1 | b | f  | l1 | l2 |     |    |   |        |      |      |       |      |        |      |
| MWLNR/L 2020 K 06  |      |   | 20 | 20 | 25 | 125 | 31 | 0604  | 100-53 | -    | 5510 | 3306  | 4188 | VBL03L | -    |
| MWLNR/L 2525 M 06  |      |   | 25 | 25 | 32 | 150 | 25 |   |        |      |      |       |      |        |      |
| MWLNR/L 2020 K 08N |      |   | 20 | 20 | 25 | 125 | 28 | 0804  | 100-52 | 5025 | -    | 3308M | 4192 | 4196   | 5003 |
| MWLNR/L 2525 M 08N |      |   | 25 | 25 | 32 | 150 | 31 |   |        |      |      |       |      |        |      |
| MWLNR/L 3232 P 08N |      |   | 32 | 32 | 40 | 170 | 31 |   |        |      |      |       |      |        |      |

Order example:  
Right hand MWLNR 2020 K 06  
Left hand MWLNL 2020 K 06

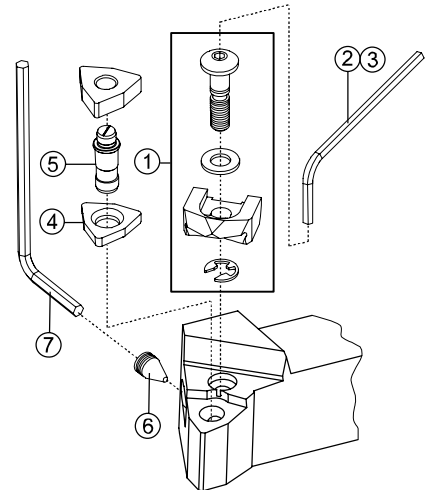

**MCLNR/L**  
**Ø20x20 – 40x40**  
**95°**

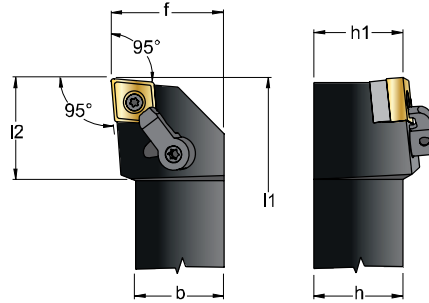

Right hand holder shown

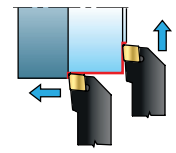









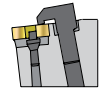

















CNMA 

CNMG 

CNMM 

**M**



| Ordering Code     |  |    | mm   |     |    |      |   |    | ①  | ②   | ③   | ④  | ⑤  |
|-------------------|---|----|------|-----|----|------|---|---|---|--|---|---|---|
|                   |   |    | h=h1 | b   | f  | l1   | l2  |   |   |  |   |   |   |
| MCLNR/L 2020 K 12 | 20  | 20 | 25   | 125 | 28 | 1204 |  | ①  | ②  | ③  | ④  | ⑤  |   |
| MCLNR/L 2525 M 12 | 25  | 25 | 32   | 150 | 33 |      |   |   |   |  |   |   |   |
| MCLNR/L 3225 P 12 | 32  | 25 | 32   | 170 | 28 |      |   |   |   |  |   |   |   |
| MCLNR/L 3232 P 12 | 32  | 32 | 40   | 170 | 30 |      |   |   |   |  |   |   |   |
| MCLNR/L 2525 M 16 | 25  | 25 | 32   | 150 | 33 | 1606 |  | ①  | ②  | ③  | ④  | ⑤  |   |
| MCLNR/L 3225 P 16 | 32  | 25 | 32   | 170 | 33 |      |   |   |   |  |   |   |   |
| MCLNR/L 3232 P 16 | 32  | 32 | 40   | 170 | 33 |      |   |   |   |  |   |   |   |
| MCLNR/L 3232 P 19 | 32  | 32 | 40   | 170 | 40 | 1906 |  | ①  | ②  | ③  | ④  | ⑤  |   |
| MCLNR/L 4040 S 19 | 40  | 40 | 50   | 250 | 40 |      |   |   |   |  |   |   |   |

**Order example:**  
Right hand MCLNR 2020 K 12  
Left hand MCLNL 2020 K 12

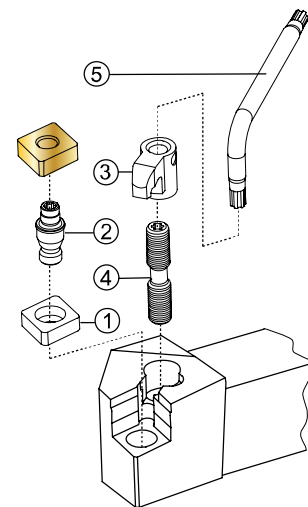

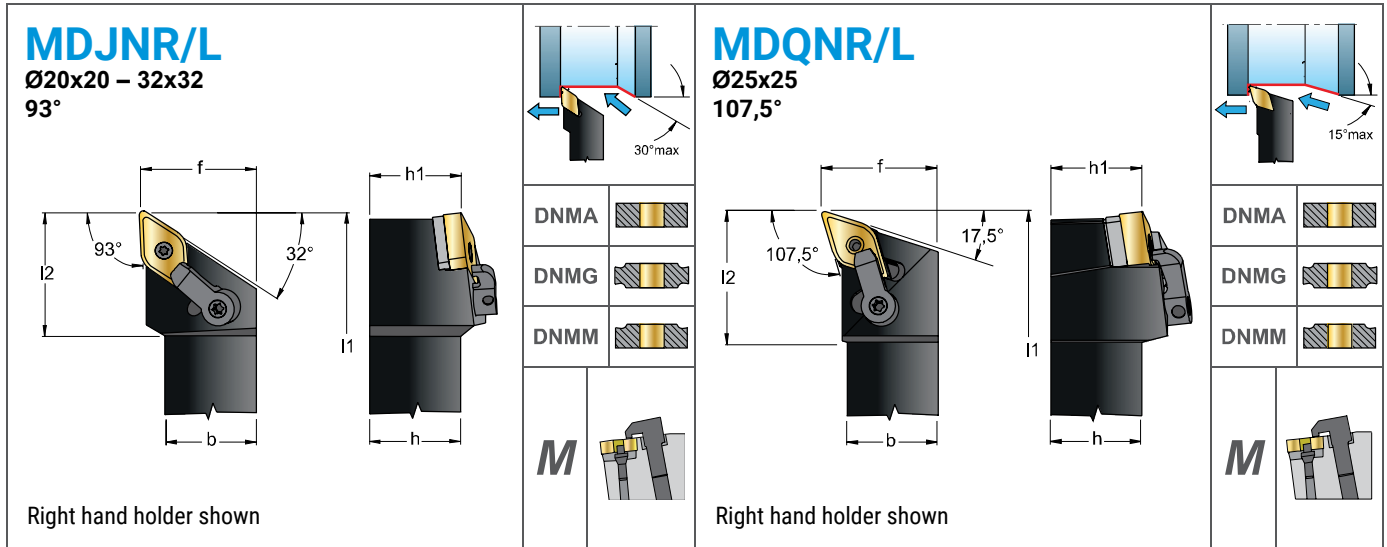

| Ordering Code | R L  |      | mm |    |    |     |    |  | ①      | ②       | ③      | ④      | ⑤    |
|---------------|------|------|----|----|----|-----|----|---|--------|---------|--------|--------|------|
|               | h=h1 | b    | f  | l1 | l2 |     |    |   |        |         |        |        |      |
| MDJNR/L       | 2020 | K 15 | 20 | 20 | 25 | 125 | 35 | 1506  | KDN433 | KLM 46L | CKM 22 | STCM20 | 5415 |
| MDJNR/L       | 2525 | M 15 | 25 | 25 | 32 | 150 | 35 |   |        |         |        |        |      |
| MDJNR/L       | 3225 | P 15 | 32 | 25 | 32 | 170 | 36 |   |        |         |        |        |      |
| MDJNR/L       | 3232 | P 15 | 32 | 32 | 40 | 170 | 36 |   |        |         |        |        |      |
| MDQNR/L       | 2525 | M 15 | 25 | 25 | 32 | 150 | 36 | 1506  | KDN433 | KLM 46L | CKM 22 | STCM20 | 5415 |

Order example:  
Right hand MDJNR 2020 K 15  
Left hand MDJNL 2020 K 15

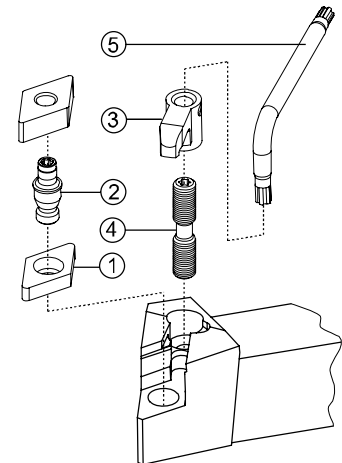

### MSSNR/L

Ø20x20 – 40x40  
45°

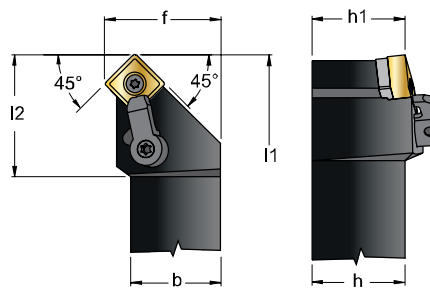

Right hand holder shown

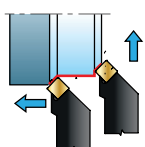

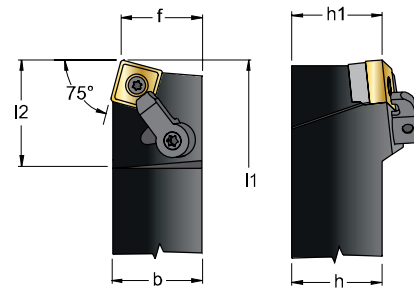

### MSBNR/L

Ø32x32 – 40x40  
75°



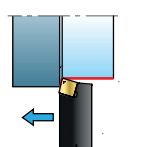

Right hand holder shown









**SNMA** 

**SNMG** 

**SNMM** 

**M** 

| Ordering Code     |  |  | mm   |    |    |     |    |  | ①  | ②  | ③  | ④  | ⑤  |
|-------------------|---|--|------|----|----|-----|----|---|---|---|--|---|---|
|                   |   |  | h=h1 | b  | f  | l1  | l2 |   |   |   |  |   |   |
| MSSNR/L 2020 K 12 |   |  | 20   | 20 | 25 | 125 | 32 |   |   |   |  |   |   |
| MSSNR/L 2525 M 12 |   |  | 25   | 25 | 32 | 150 | 33 | 1204  | KSN433  | KLM 46  | CKM 21   | STCM20  | 5415  |
| MSSNR/L 3232 P 12 |   |  | 32   | 32 | 40 | 170 | 40 |   |   |   |  |   |   |
| MSSNR/L 3232 P 19 |   |  | 32   | 32 | 40 | 170 | 40 | 1906  | KSN633  | KLM 68  | CKM 12   | STCM4   | 5425  |
| MSSNR/L 4040 S 19 |   |  | 40   | 40 | 50 | 250 | 40 |   |   |   |  |   |   |
| MSBNR/L 3232 P 19 |   |  | 32   | 32 | 27 | 170 | 39 | 1906  | KSN633  | KLM 68  | CKM 12   | STCM4   | 5425  |
| MSBNR/L 4040 S 19 |   |  | 40   | 40 | 35 | 250 | 39 |   |   |   |  |   |   |

*Order example:*  
Right hand MSSNR 2020 K 12  
Left hand MSSNL 2020 K 12

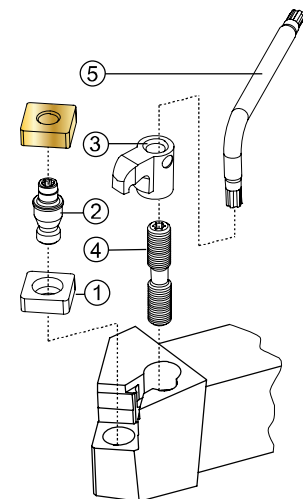

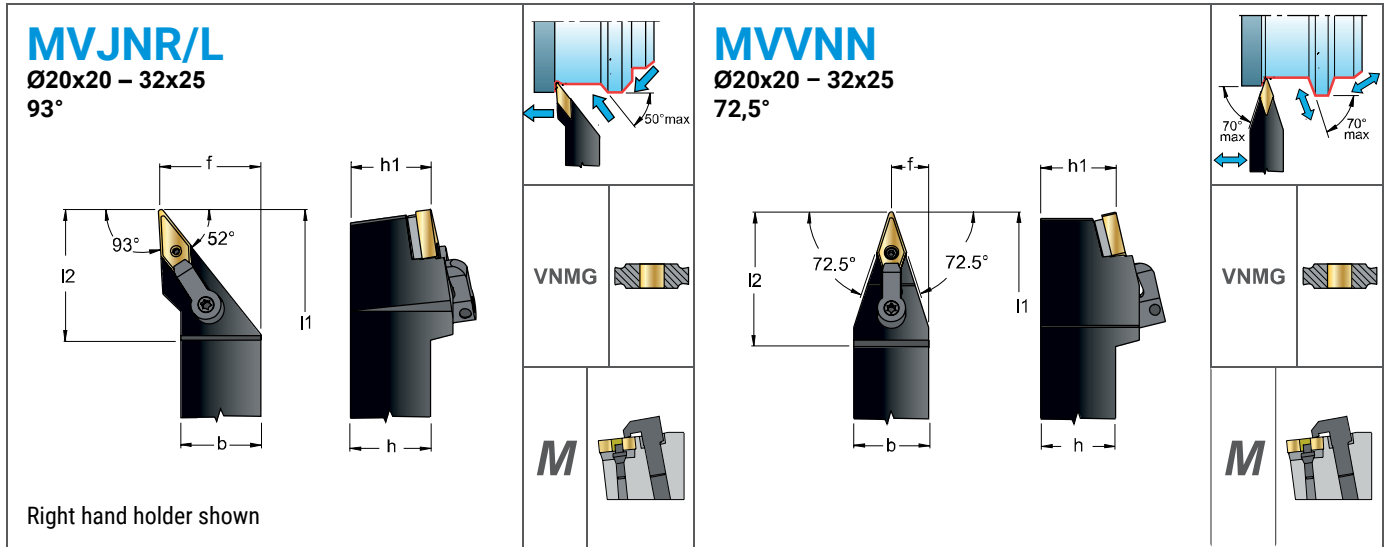

| Ordering Code | R L  |      | mm |    |      |     |    |  | ①      | ②      | ③    | ④     | ⑤      | ⑥    |
|---------------|------|------|----|----|------|-----|----|---|--------|--------|------|-------|--------|------|
|               | h=h1 | b    | f  | l1 | l2   |     |    |   |        |        |      |       |        |      |
| MVJNR/L       | 2020 | K 16 | 20 | 20 | 25   | 125 | 32 |   |        |        |      |       |        |      |
| MVJNR/L       | 2525 | M 16 | 25 | 25 | 32   | 150 | 32 | 1604  | KVN323 | KLM34L | 5508 | CKM22 | STCM20 | 5415 |
| MVJNR/L       | 3225 | P 16 | 32 | 25 | 32   | 170 | 32 |   |        |        |      |       |        |      |
| MVVNN         | 2020 | K 16 | 20 | 20 | 10   | 125 | 45 |   |        |        |      |       |        |      |
| MVVNN         | 2525 | M 16 | 25 | 25 | 12,5 | 150 | 45 | 1604  | KVN323 | KLM34L | 5508 | CKM22 | STCM20 | 5415 |
| MVVNN         | 3225 | P 16 | 32 | 25 | 12,5 | 170 | 45 |   |        |        |      |       |        |      |

**Order example:**  
 Right hand MVJNR 2020 K 16  
 Left hand MVJNL 2020 K 16  
 Neutral MVVNN 2020 K 16

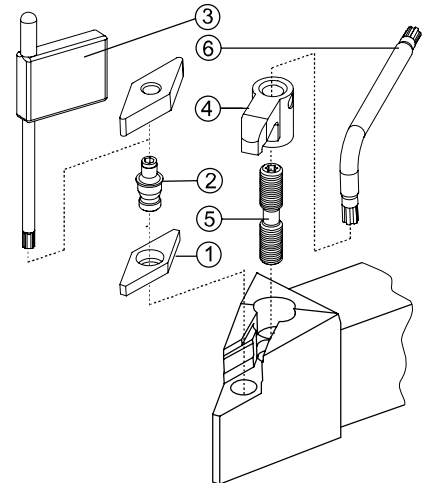

**MVPCR/L**  
Ø20x20 – 32x25  
117,5°

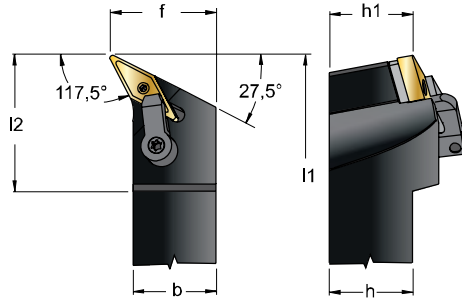

Right hand holder shown

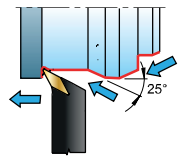



VNMG



M



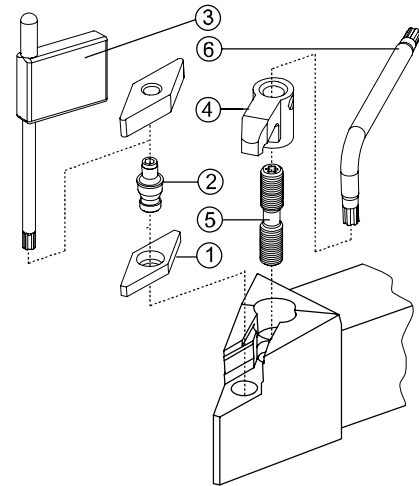

| Ordering Code |  |      | mm   |    |    |     |    |  | ①      | ②      | ③    | ④     | ⑤      | ⑥    |
|---------------|---|------|------|----|----|-----|----|---|--------|--------|------|-------|--------|------|
|               |   |      | h=h1 | b  | f  | l1  | l2 |   |        |        |      |       |        |      |
| MVPCR/L       | 2020  | K 16 | 20   | 20 | 25 | 125 | 41 |   |        |        |      |       |        |      |
| MVPCR/L       | 2525  | M 16 | 25   | 25 | 32 | 150 | 41 | 1604  | KVN323 | KLM34L | 5508 | CKM22 | STCM20 | 5415 |
| MVPCR/L       | 3225  | P 16 | 32   | 25 | 32 | 170 | 32 |   |        |        |      |       |        |      |

Order example:  
Right hand MVPCR 2020 K 16  
Left hand MVPNL 2020 K 16

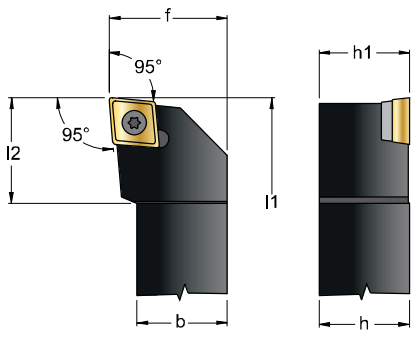
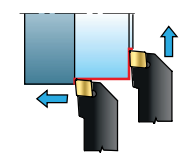

**SCLCR/L**  
Ø08x08 – 25x25  
95°



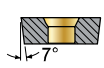
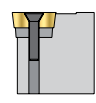

|      |   |
|------|---|
| CC.T |  |
| CC.W |  |
| S    |  |

Right hand holder shown

| Ordering Code     | mm |   |      |    |    |  Nm |  | ①       | ②    | ③    | ④     |         |       |
|-------------------|----|---|------|----|----|--|---|---------|------|------|-------|---------|-------|
|                   | R  | L | h=h1 | b  | f  |  |   |         |      |      |       | l1      | l2    |
| SCLCR/L 0808 D 06 |    |   | 8    | 8  | 10 | 60   | 10  | 1,1÷1,3 | 0602 | -    | -     | 12256P  | 5508P |
| SCLCR/L 1010 E 06 |    |   | 10   | 10 | 12 | 70   | 10  | 1,1÷1,3 |      |      |       |         |       |
| SCLCR/L 1212 F 09 |    |   | 12   | 12 | 16 | 80   | 15  | 3,8÷5,0 | 09T3 | -    | -     | 12409P  | 5515P |
| SCLCR/L 1616 H 09 |    |   | 16   | 16 | 20 | 100  | 15  | 3,0÷3,5 |      |      |       |         |       |
| SCLCR/L 2020 K 09 |    |   | 20   | 20 | 25 | 125  | 17  | 3,0÷3,5 | 09T3 | 3609 | BCL7  | 123511P | 5515P |
| SCLCR/L 2525 M 09 |    |   | 25   | 25 | 32 | 150  | 18  | 3,0÷3,5 |      |      |       |         |       |
| SCLCR/L 1616 H 12 |    |   | 16   | 16 | 20 | 100  | 20  | 4,0÷5,0 |      |      |       |         |       |
| SCLCR/L 2020 K 12 |    |   | 20   | 20 | 25 | 125  | 20  | 4,0÷5,0 | 1204 | 3611 | BCL15 | 124513P | 5520P |
| SCLCR/L 2525 M 12 |    |   | 25   | 25 | 32 | 150  | 20  | 4,0÷5,0 |      |      |       |         |       |

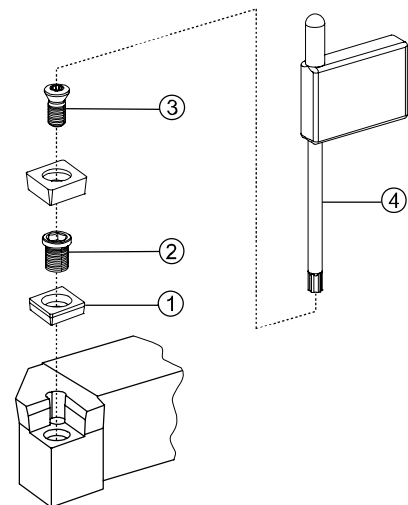
Order example:  
Right hand SCLCR 0808 D 06  
Left hand SCLCL 0808 D 06



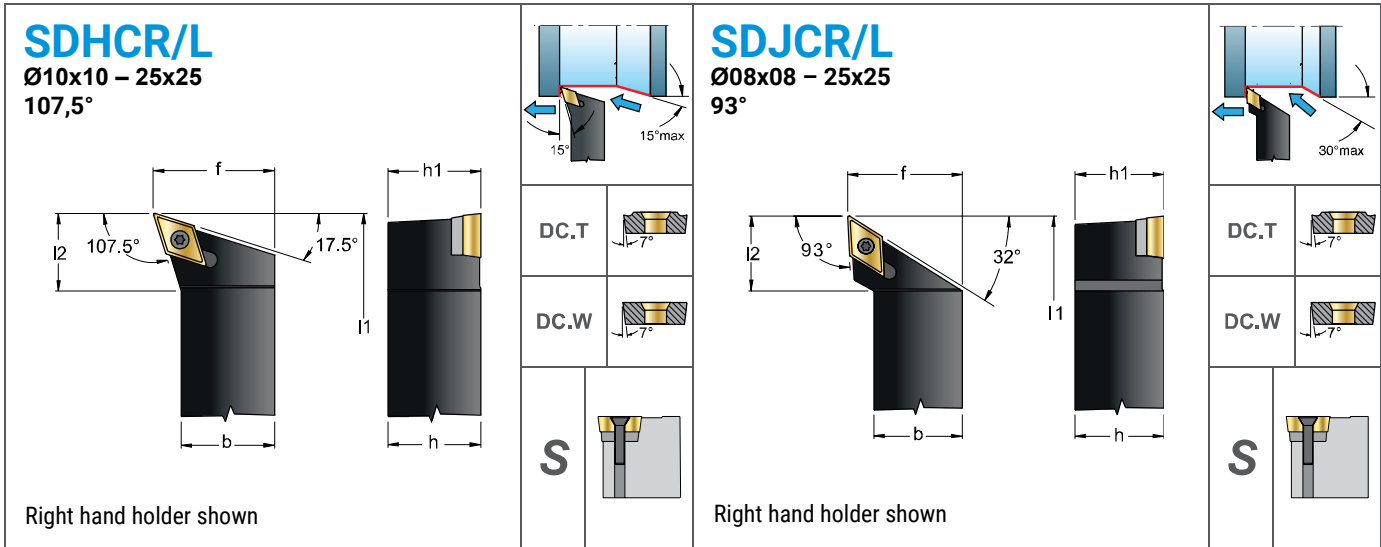

| Ordering Code     | R L  |    | mm |     |    |         |      | Nm   | 0702 | ①       | ②     | ③ | ④ |
|-------------------|------|----|----|-----|----|---------|------|------|------|---------|-------|---|---|
|                   | h=h1 | b  | f  | l1  | l2 |         |      |      |      |         |       |   |   |
| SDHCR/L 1010 E 07 | 10   | 10 | 12 | 70  | 10 | 1,1÷1,3 | 0702 | -    | -    | 12256P  | 5508P |   |   |
| SDHCR/L 1212 F 07 | 12   | 12 | 16 | 80  | 12 | 1,1÷1,3 |      |      |      |         |       |   |   |
| SDHCR/L 1616 H 11 | 16   | 16 | 20 | 100 | 19 | 3,0÷3,5 | 11T3 | 3711 | BCL7 | 123511P | 5515P |   |   |
| SDHCR/L 2020 K 11 | 20   | 20 | 25 | 125 | 18 | 3,0÷3,5 |      |      |      |         |       |   |   |
| SDHCR/L 2525 M 11 | 25   | 25 | 32 | 150 | 20 | 3,0÷3,5 |      |      |      |         |       |   |   |
| SDJCR/L 0808 D 07 | 8    | 8  | 10 | 60  | 14 | 1,1÷1,3 | 0702 | -    | -    | 12256P  | 5508P |   |   |
| SDJCR/L 1010 E 07 | 10   | 10 | 12 | 70  | 14 | 1,1÷1,3 |      |      |      |         |       |   |   |
| SDJCR/L 1212 F 07 | 12   | 12 | 16 | 80  | 14 | 1,1÷1,3 |      |      |      |         |       |   |   |
| SDJCR/L 1212 F 11 | 12   | 12 | 16 | 80  | 21 | 3,8÷5,0 | 11T3 | -    | -    | 12409P  | 5515P |   |   |
| SDJCR/L 1616 H 11 | 16   | 16 | 20 | 100 | 22 | 3,0÷3,5 | 11T3 | 3711 | BCL7 | 123511P | 5515P |   |   |
| SDJCR/L 2020 K 11 | 20   | 20 | 25 | 125 | 23 | 3,0÷3,5 |      |      |      |         |       |   |   |
| SDJCR/L 2525 M 11 | 25   | 25 | 32 | 150 | 27 | 3,0÷3,5 |      |      |      |         |       |   |   |

Order example:  
Right hand SDHCR 1010 E 07  
Left hand SDHCL 1010 E 07

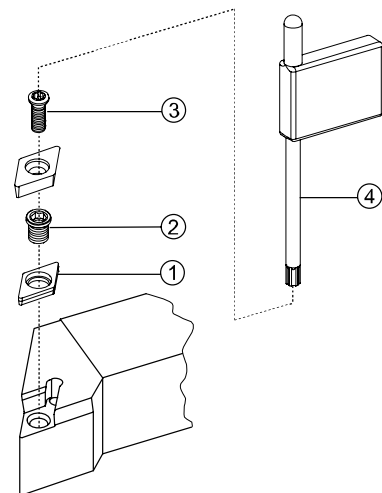



**SDNCN**

Ø08x08 – 25x25  
63°

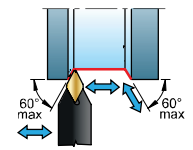
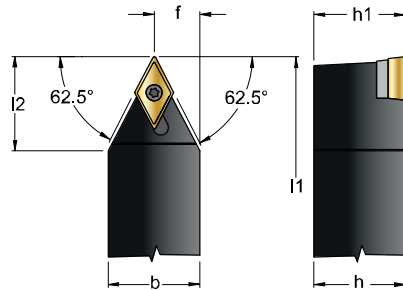

DC.T









DC.W



**S**



| Ordering Code   |  |  | mm   |    |      |     |    | <br>Nm |  | ①<br> | ②<br> | ③<br> | ④<br> |
|-----------------|---|--|------|----|------|-----|----|---|---|--|---|--|--|
|                 |   |  | h=h1 | b  | f    | l1  | l2 |   |   |  |   |  |  |
| SDNCN 0808 D 07 |   |  | 8    | 8  | 4,0  | 60  | 9  | 1,1÷1,3   |   |  |   |  |  |
| SDNCN 1010 E 07 |   |  | 10   | 10 | 5,0  | 70  | 11 | 1,1÷1,3   | 0702  | -  | -   | 12256P   | 5508P  |
| SDNCN 1212 F 07 |   |  | 12   | 12 | 6,0  | 80  | 13 | 1,1÷1,3   |   |  |   |  |  |
| SDNCN 1212 F 11 |   |  | 12   | 12 | 6,0  | 80  | 12 | 3,8÷5,0   | 11T3  | -  | -   | 12409P   | 5515P  |
| SDNCN 1616 H 11 |   |  | 16   | 16 | 8,0  | 100 | 16 | 3,0÷3,5   |   |  |   |  |  |
| SDNCN 2020 K 11 |   |  | 20   | 20 | 10,0 | 125 | 20 | 3,0÷3,5   | 11T3  | 3711   | BCL7  | 123511P  | 5515P  |
| SDNCN 2525 M 11 |   |  | 25   | 25 | 12,5 | 150 | 25 | 3,0÷3,5   |   |  |   |  |  |

Order example:  
Neutral SDNCN 0808 D 07

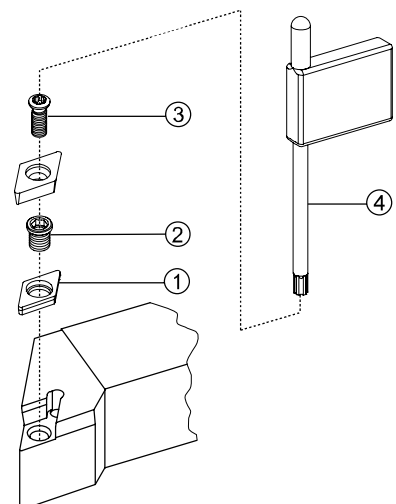

**SRDCN**  
Ø12x12 – 25x25

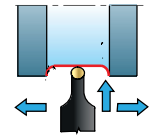
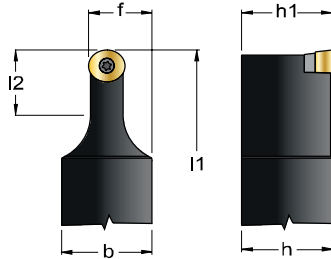

RC.T





RC.W



**S**



| Ordering Code |  |      | mm   |    |      |     |      | <br>Nm |  | ①    | ②    | ③       | ④     |
|---------------|---|------|------|----|------|-----|------|---|---|------|------|---------|-------|
|               |   |      | h=h1 | b  | f    | l1  | l2   |   |   |      |      |         |       |
| SRDCN         | 1212  | F 06 | 12   | 12 | 9,0  | 80  | 12,5 | 1,1÷1,3   | 0602MO  | -    | -    | 12256P  | 5508P |
| SRDCN         | 1616  | H 06 | 16   | 16 | 11,0 | 100 | 12,5 | 1,1÷1,3   |   | -    | -    | 12256P  | 5508P |
| SRDCN         | 2020  | K 06 | 20   | 20 | 13,0 | 125 | 12,5 | 1,1÷1,3   |   | -    | -    | 12256P  | 5508P |
| SRDCN         | 2525  | M 06 | 25   | 25 | 15,5 | 150 | 12,5 | 1,1÷1,3   |   | -    | -    | 12256P  | 5508P |
| SRDCN         | 1616  | H 08 | 16   | 16 | 12,0 | 100 | 16,5 | 1,2÷1,5   | 0803MO  | -    | -    | 123008P | 5508P |
| SRDCN         | 2020  | K 08 | 20   | 20 | 14,0 | 125 | 16,5 | 1,2÷1,5   |   | -    | -    | 123008P | 5508P |
| SRDCN         | 2525  | M 08 | 25   | 25 | 16,5 | 150 | 16,5 | 1,2÷1,5   |   | -    | -    | 123008P | 5508P |
| SRDCN         | 1616  | H 10 | 16   | 16 | 13,0 | 100 | 20,5 | 3,0÷3,5   | 1003MO  | 3810 | BCL7 | 123511P | 5515P |
| SRDCN         | 2020  | K 10 | 20   | 20 | 15,0 | 125 | 20,5 | 3,0÷3,5   |   | 3810 | BCL7 | 123511P | 5515P |
| SRDCN         | 2525  | M 10 | 25   | 25 | 17,5 | 150 | 20,5 | 3,0÷3,5   |   | 3810 | BCL7 | 123511P | 5515P |

Order example:  
Neutral SRDCN 1212 F 06

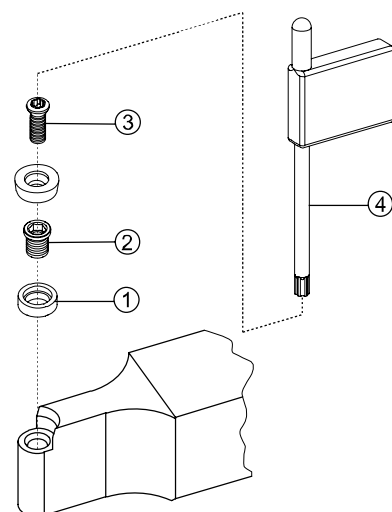

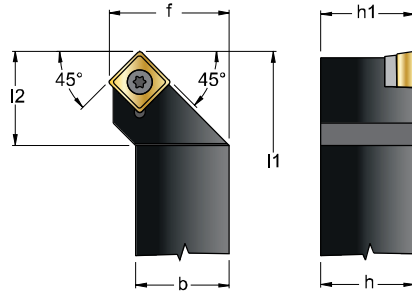

**SSSCR/L**  
Ø12x12 – 25x25  
45°

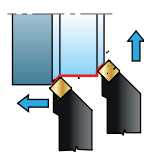

Right hand holder shown

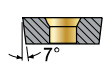

|      |   |
|------|---|
| SC.T |  |
| SC.W |  |
| S    |  |

| Ordering Code | R L  |   | mm   |    |    |    |     | Nm | Insert  | ①    | ②    | ③     | ④       |       |
|---------------|------|---|------|----|----|----|-----|----|---------|------|------|-------|---------|-------|
|               |      |   | h=h1 | b  | f  | l1 | l2  |    |         | 1    | 2    | 3     | 4       |       |
| SSSCR/L       | 1212 | F | 09   | 12 | 12 | 16 | 80  | 19 | 3,8÷5,0 | 09T3 | -    | -     | 12409P  | 5515P |
| SSSCR/L       | 1616 | H | 09   | 16 | 16 | 20 | 100 | 22 | 3,0÷3,5 | 09T3 | 3509 | BCL7  | 123511P | 5515P |
| SSSCR/L       | 2020 | K | 09   | 20 | 20 | 25 | 125 | 23 | 3,0÷3,5 |      |      |       |         |       |
| SSSCR/L       | 1616 | H | 12   | 16 | 16 | 20 | 100 | 22 | 4,0÷5,0 | 1204 | 3511 | BCL15 | 124513P | 5520P |
| SSSCR/L       | 2020 | K | 12   | 20 | 20 | 25 | 125 | 23 | 4,0÷5,0 |      |      |       |         |       |
| SSSCR/L       | 2525 | M | 12   | 25 | 25 | 32 | 150 | 27 | 4,0÷5,0 |      |      |       |         |       |

Order example:  
Right hand SSSCR 1212 F 09  
Left hand SSSCL 1212 F 09

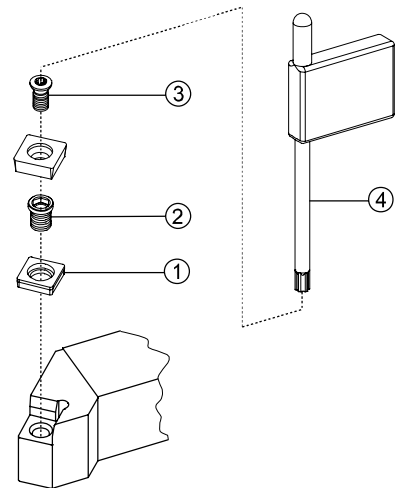

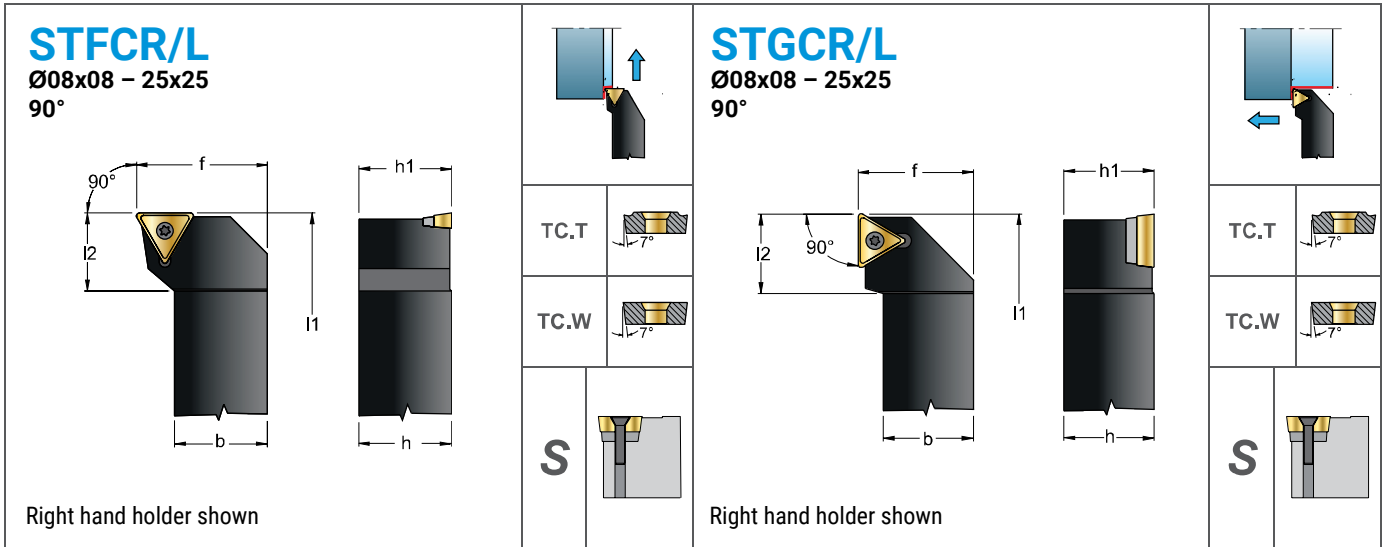

| Ordering Code     | R L  |    | mm |     |    |         |      | Nm   | 0902 | 1       | 2     | 3 | 4 |
|-------------------|------|----|----|-----|----|---------|------|------|------|---------|-------|---|---|
|                   | h=h1 | b  | f  | l1  | l2 |         |      |      |      |         |       |   |   |
| STFCR/L 0808 D 09 | 8    | 8  | 10 | 60  | 10 | 0,9÷1,0 | 1102 | -    | -    | 12225P  | 5507P |   |   |
| STFCR/L 1010 E 09 | 10   | 10 | 12 | 70  | 10 | 0,9÷1,0 |      | -    | -    | 12256P  | 5508P |   |   |
| STFCR/L 1212 F 11 | 12   | 12 | 16 | 80  | 14 | 1,1÷1,3 |      | -    | -    | 123511P | 5515P |   |   |
| STFCR/L 1616 H 11 | 16   | 16 | 20 | 100 | 15 | 1,1÷1,3 | 16T3 | 3415 | BCL7 | 123511P | 5515P |   |   |
| STFCR/L 1616 H 16 | 16   | 16 | 20 | 100 | 20 | 3,0÷3,5 |      | -    | -    | -       | -     |   |   |
| STFCR/L 2020 K 16 | 20   | 20 | 25 | 125 | 23 | 3,0÷3,5 |      | -    | -    | -       | -     |   |   |
| STFCR/L 2525 M 16 | 25   | 25 | 32 | 150 | 23 | 3,0÷3,5 | -    | -    | -    | -       |       |   |   |

|                   |    |    |    |     |    |         |      |      |      |         |       |
|-------------------|----|----|----|-----|----|---------|------|------|------|---------|-------|
| STGCR/L 0808 D 09 | 8  | 8  | 10 | 60  | 10 | 0,9÷1,0 | 1102 | -    | -    | 12225P  | 5507P |
| STGCR/L 1010 E 09 | 10 | 10 | 12 | 70  | 10 | 0,9÷1,0 |      | -    | -    | 12256P  | 5508P |
| STGCR/L 1212 F 11 | 12 | 12 | 16 | 80  | 15 | 1,1÷1,3 |      | -    | -    | 123511P | 5515P |
| STGCR/L 1616 H 11 | 16 | 16 | 20 | 100 | 15 | 1,1÷1,3 | 16T3 | 3415 | BCL7 | 123511P | 5515P |
| STGCR/L 1616 H 16 | 16 | 16 | 20 | 100 | 20 | 3,0÷3,5 |      | -    | -    | -       | -     |
| STGCR/L 2020 K 16 | 20 | 20 | 25 | 125 | 20 | 3,0÷3,5 |      | -    | -    | -       | -     |
| STGCR/L 2525 M 16 | 25 | 25 | 32 | 150 | 20 | 3,0÷3,5 | -    | -    | -    | -       |       |

Order example:  
Right hand STFGR 0808 D 09  
Left hand STFCL 0808 D 09

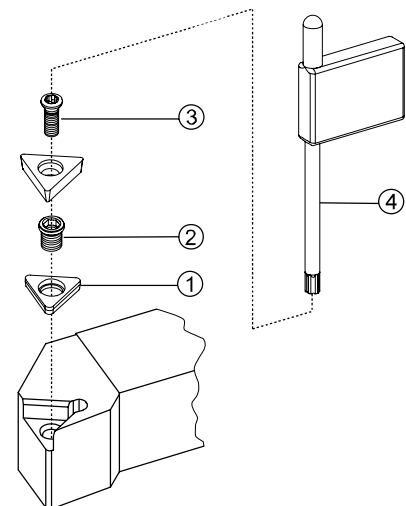

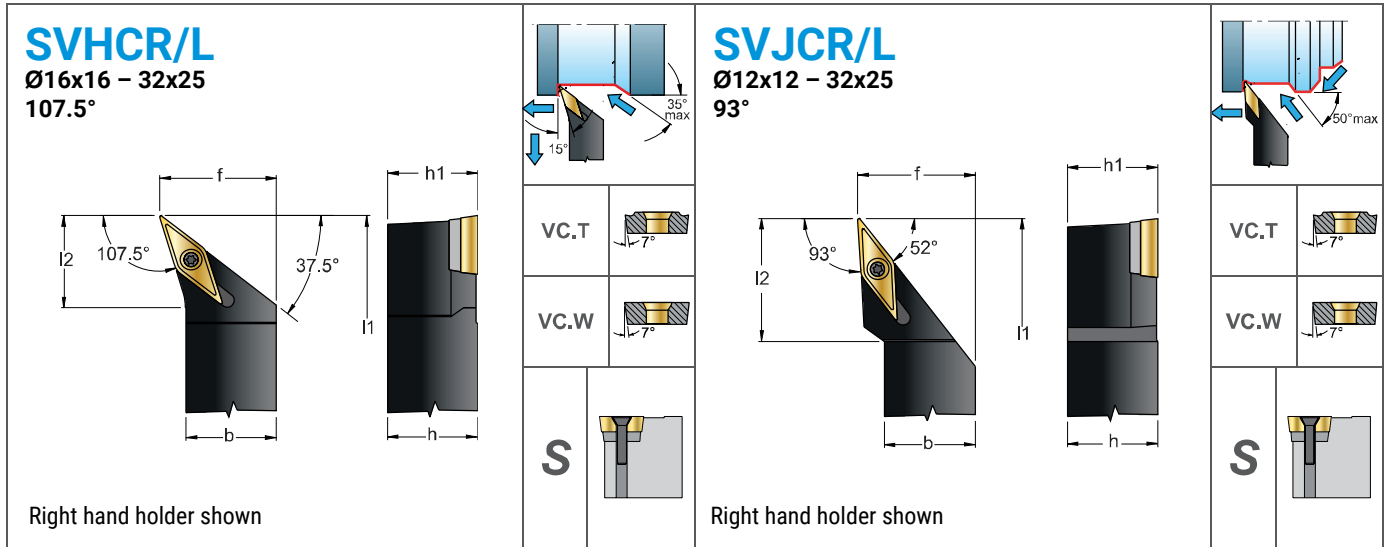

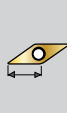

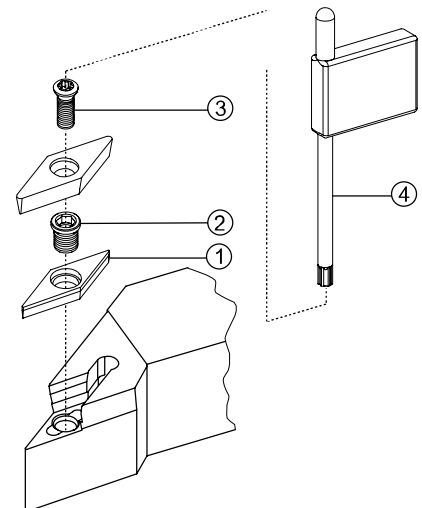

| Ordering Code     | R L  |    | mm |     |    |         |      | Nm   |  | ①       | ②     | ③ | ④ |
|-------------------|------|----|----|-----|----|---------|------|------|---|---------|-------|---|---|
|                   | h=h1 | b  | f  | l1  | l2 |         |      |      |   |         |       |   |   |
| SVHCR/L 1616 H 11 | 16   | 16 | 20 | 100 | 15 | 1,1÷1,3 | 1103 | -    | -   | 12256P  | 5508P |   |   |
| SVHCR/L 2020 K 11 | 20   | 20 | 25 | 125 | 18 | 1,1÷1,3 |      |      |   |         |       |   |   |
| SVHCR/L 2525 M 11 | 25   | 25 | 32 | 150 | 25 | 1,1÷1,3 |      |      |   |         |       |   |   |
| SVHCR/L 2020 K 16 | 20   | 20 | 25 | 125 | 17 | 3,0÷3,5 | 1604 | 3716 | BCL7  | 123511P | 5515P |   |   |
| SVHCR/L 2525 M 16 | 25   | 25 | 32 | 150 | 23 | 3,0÷3,5 |      |      |   |         |       |   |   |
| SVHCR/L 3225 P 16 | 32   | 25 | 32 | 170 | 23 | 3,0÷3,5 |      |      |   |         |       |   |   |

|                   |    |    |    |     |    |         |      |      |      |         |       |
|-------------------|----|----|----|-----|----|---------|------|------|------|---------|-------|
| SVJCR/L 1212 F 11 | 12 | 12 | 16 | 80  | 21 | 1,1÷1,3 | 1103 | -    | -    | 12256P  | 5508P |
| SVJCR/L 1616 H 11 | 16 | 16 | 20 | 100 | 24 | 1,1÷1,3 |      |      |      |         |       |
| SVJCR/L 2020 K 11 | 20 | 20 | 25 | 125 | 23 | 1,1÷1,3 |      |      |      |         |       |
| SVJCR/L 2525 M 11 | 25 | 25 | 32 | 150 | 27 | 1,1÷1,3 | 1604 | 3716 | BCL7 | 123511P | 5515P |
| SVJCR/L 2020 K 16 | 20 | 20 | 25 | 125 | 30 | 3,0÷3,5 |      |      |      |         |       |
| SVJCR/L 2525 M 16 | 25 | 25 | 32 | 150 | 33 | 3,0÷3,5 |      |      |      |         |       |
| SVJCR/L 3225 P 16 | 32 | 25 | 32 | 170 | 33 | 3,0÷3,5 |      |      |      |         |       |

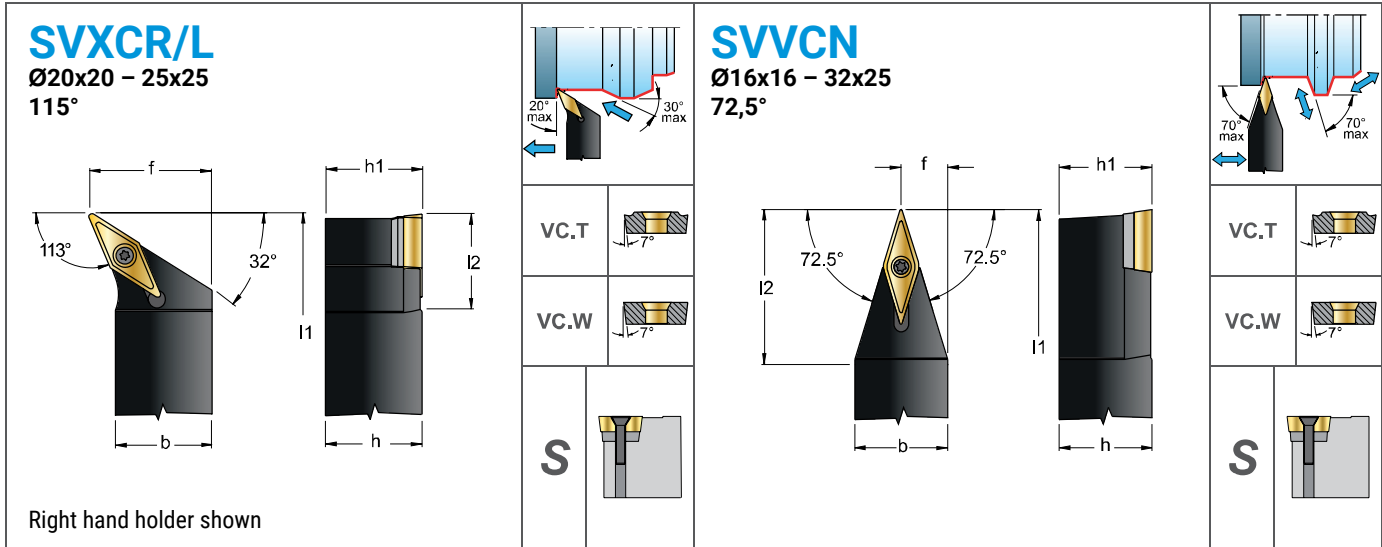
Order example:  
Right hand SVHCR 1616 H 11  
Left hand SVHCL 1616 H 11





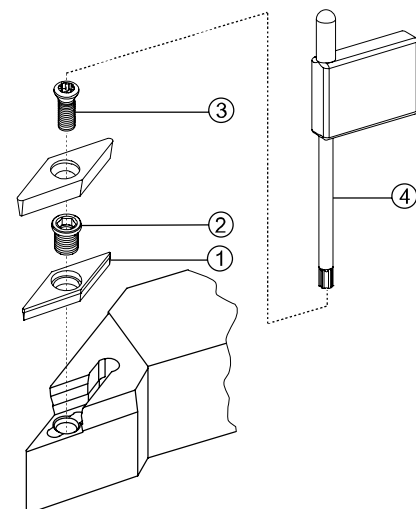

| Ordering Code     |  |    | mm   |     |    |         |      |      | <br>Nm |  | ①     | ② | ③ | ④ |
|-------------------|---|----|------|-----|----|---------|------|------|---|---|-------|---|---|---|
|                   |   |    | h=h1 | b   | f  | l1      | l2   |      |   |   |       |   |   |   |
| SVXCR/L 2020 K 16 | 20  | 20 | 25   | 125 | 25 | 3,0÷3,5 | 1604 | 3716 | BCL7  | 123511P   | 5515P |   |   |   |
| SVXCR/L 2525 M 16 | 25  | 25 | 32   | 150 | 25 | 3,0÷3,5 |      |      |   |   |       |   |   |   |
| SVVCN 1616 H 11   | 16  | 16 | 8,0  | 100 | 26 | 1,1÷1,3 |      |      |   |   |       |   |   |   |
| SVVCN 2020 K 11   | 20  | 20 | 10,0 | 125 | 32 | 1,1÷1,3 | 1103 | -    | -   | 12256P  | 5508P |   |   |   |
| SVVCN 2525 M 11   | 25  | 25 | 12,5 | 150 | 40 | 1,1÷1,3 |      |      |   |   |       |   |   |   |
| SVVCN 2020 K 16   | 20  | 20 | 10,0 | 125 | 34 | 3,0÷3,5 |      |      |   |   |       |   |   |   |
| SVVCN 2525 M 16   | 25  | 25 | 12,5 | 150 | 42 | 3,0÷3,5 | 1604 | 3716 | BCL7  | 123511P   | 5515P |   |   |   |
| SVVCN 3225 P 16   | 32  | 25 | 12,5 | 170 | 42 | 3,0÷3,5 |      |      |   |   |       |   |   |   |

*Order example:*  
 Right hand SVXCR 2020 K 16  
 Left hand SVXCL 2020 K 16  
 Neutral SVVCN 1616 H 11

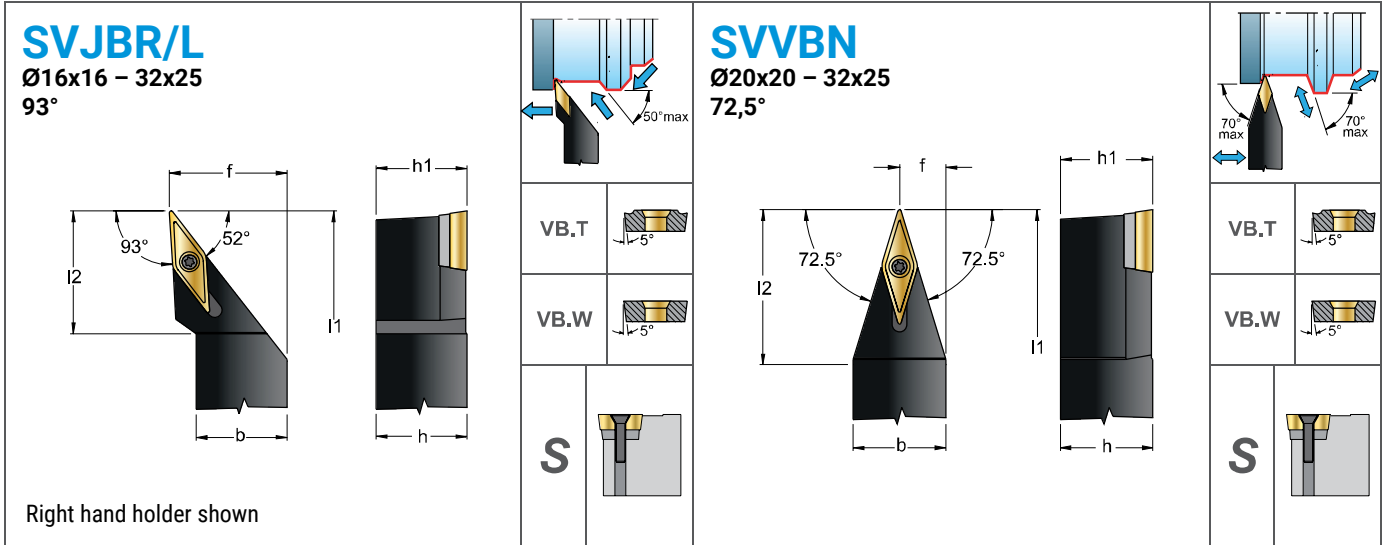



| Ordering Code | R L  |      | mm |    |      |     |    | Nm      |  | ①    | ②    | ③       | ④     |
|---------------|------|------|----|----|------|-----|----|---------|---|------|------|---------|-------|
|               | h=h1 | b    | f  | l1 | l2   |     |    |         |   |      |      |         |       |
| SVJBR/L       | 1616 | H 16 | 16 | 16 | 20   | 100 | 30 | 3,0÷3,5 | 1604  | 3716 | BCL7 | 123511P | 5515P |
| SVJBR/L       | 2020 | K 16 | 20 | 20 | 25   | 125 | 30 | 3,0÷3,5 |   |      |      |         |       |
| SVJBR/L       | 2525 | M 16 | 25 | 25 | 32   | 150 | 33 | 3,0÷3,5 |   |      |      |         |       |
| SVJBR/L       | 3225 | P 16 | 32 | 25 | 32   | 170 | 33 | 3,0÷3,5 |   |      |      |         |       |
| SVVBN         | 2020 | K 16 | 20 | 20 | 10,0 | 125 | 34 | 3,0÷3,5 | 1604  | 3716 | BCL7 | 123511P | 5515P |
| SVVBN         | 2525 | M 16 | 25 | 25 | 12,5 | 150 | 42 | 3,0÷3,5 |   |      |      |         |       |
| SVVBN         | 3225 | P 16 | 32 | 25 | 12,5 | 170 | 42 | 3,0÷3,5 |   |      |      |         |       |

**Order example:**  
 Right hand SVJBR 1616 H 16  
 Left hand SVJBL 1616 H 16  
 Neutral SVVBN 2020 K 16

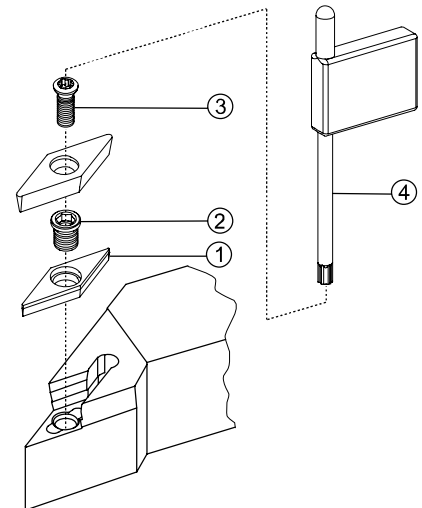

**CKJNR/L**  
Ø20x20 – 32x32  
93°

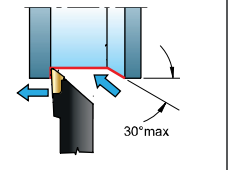
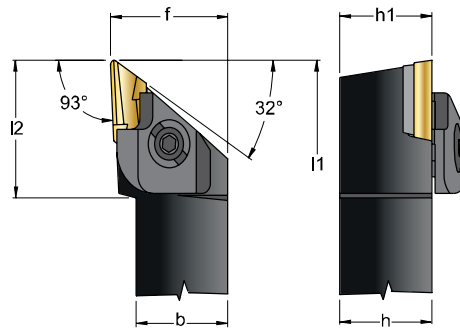









KNUX



C



Right hand holder shown

| Ordering Code |  |      | mm   |    |    |     |    |  | ①   | ②   | ③  | ④   | ⑤   | ⑥   | ⑦   |
|---------------|---|------|------|----|----|-----|----|---|---|---|--|---|---|---|---|
|               |   |      | h=h1 | b  | f  | l1  | l2 |   |   |   |  |   |   |   |   |
| CKJNR         | 2020  | K 16 | 20   | 20 | 25 | 125 | 32 |   |  |  |  |  |  |  |  |
| CKJNR         | 2525  | M 16 | 25   | 25 | 32 | 150 | 32 | 1604..-R  | 2316  | 3226  | 4012   | 1614  | 4295  | 4204  | 5004  |
| CKJNR         | 3232  | P 16 | 32   | 32 | 40 | 170 | 32 |   |   |   |  |   |   |   |   |
| CKJNL         | 2020  | K 16 | 20   | 20 | 30 | 125 | 32 |   |   |   |  |   |   |   |   |
| CKJNL         | 2525  | M 16 | 25   | 25 | 32 | 150 | 32 | 1604..-L  | 2326  | 3236  | 4012   | 1614  | 4295  | 4204  | 5004  |
| CKJNL         | 3232  | P 16 | 32   | 32 | 40 | 170 | 32 |   |   |   |  |   |   |   |   |

Order example:  
Right hand CKJNR 2020 K 16  
Left hand CKJNL 2020 K 16

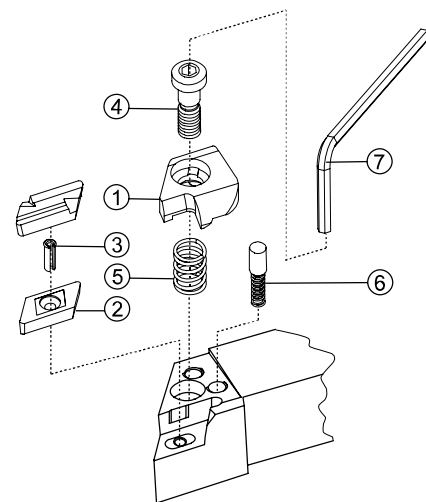



# BORING BARS

**1 Clamping type**

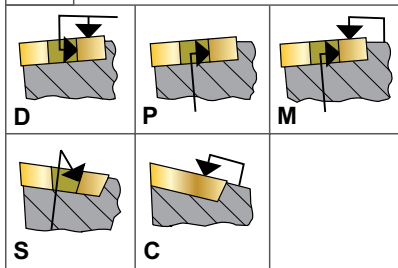

**2 Insert shape**

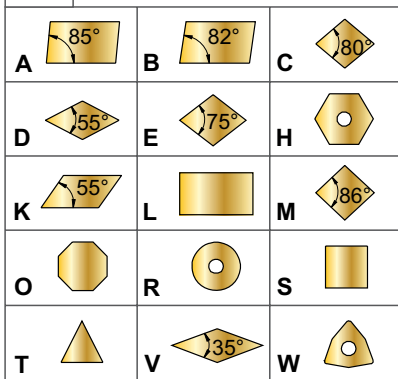

**3 Approach angle**

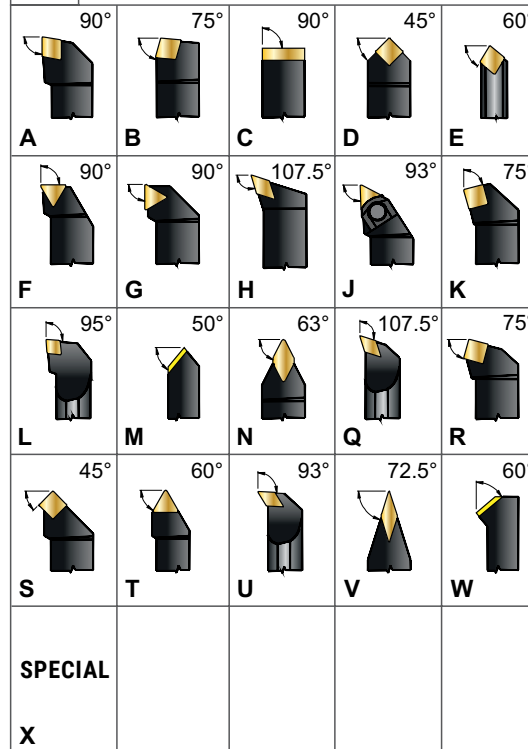

**4 Insert clearance angle**

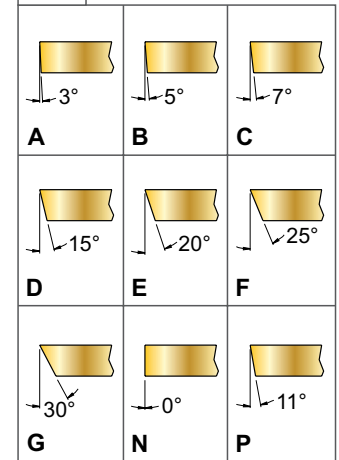

**5 Hand edge**

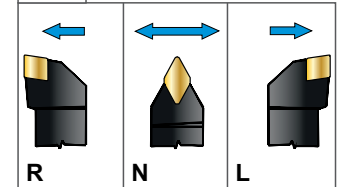

**AH 12 M S T F C R 11**  
 10 7 8 1 2 3 4 5 9

**6 Height of body**

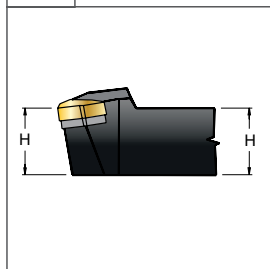

**7 Body width**

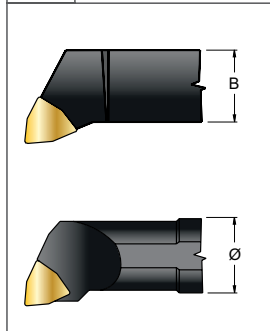

**8 Length of toolholder**

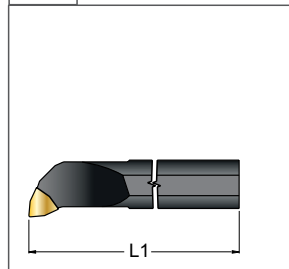

| L1 mm   | ISO |
|---------|-----|
| 32      | A   |
| 40      | B   |
| 50      | C   |
| 60      | D   |
| 70      | E   |
| 80      | F   |
| 90      | G   |
| 100     | H   |
| 110     | J   |
| 125     | K   |
| 140     | L   |
| 150     | M   |
| 160     | N   |
| 170     | P   |
| 180     | Q   |
| 200     | R   |
| 250     | S   |
| 300     | T   |
| 350     | U   |
| 400     | V   |
| 450     | W   |
| 500     | Y   |
| SPECIAL | X   |

**9 Length of cutting edge**

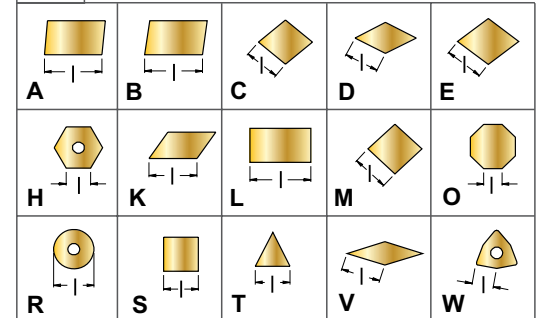

**10 Toolholder material**

AH = HSS + through coolant  
 S = steel  
 A = steel + through coolant  
 E = solid carbide + through coolant

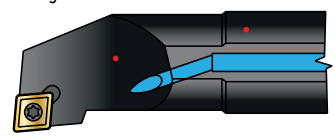

**A..DCLNR/L**

Ø25 – Ø50  
95°

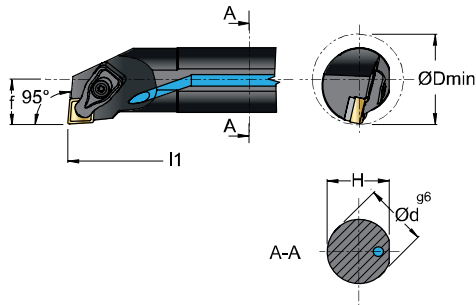



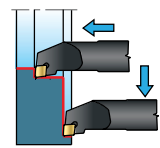



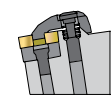

Right hand holder shown



**D**



| Ordering Code |   | mm    |    |    |    |     | <br>Nm |  | ①  | ②  | ③  | ④  | ⑤  |
|---------------|---|-------|----|----|----|-----|---|---|---|---|---|---|---|
|               |   | ØDmin | Ød | f  | H  | l1  |   |   |   |   |   |   |   |
| A25R          | DCLNR/L 12  | 32    | 25 | 17 | 24 | 200 | 3,9   | 1204  | 100-21  | 5415  | 3612  | 125009  | 5420  |
| A32S          | DCLNR/L 12  | 40    | 32 | 22 | 31 | 250 | 3,9   |   | 100-21  | 5415  | 3612  | 125011  | 5420  |
| A40T          | DCLNR/L 12  | 50    | 40 | 27 | 38 | 300 | 3,9   |   | 100-21  | 5415  | 3612  | 125011  | 5420  |
| A50U          | DCLNR/L 12  | 63    | 50 | 35 | 48 | 350 | 3,9   |   | 100-21  | 5415  | 3612  | 125011  | 5420  |
| A50U          | DCLNR/L 16  | 63    | 50 | 35 | 48 | 350 | 6,4   | 1606  | 100-31  | 5420  | 3616  | 126011  | 5425  |

Order example:  
Right hand A25R DCLNR 12  
Left hand A25R DCLNL 12

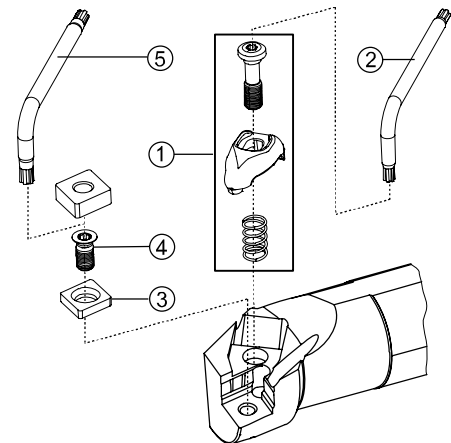

**A..DDUNR/L**



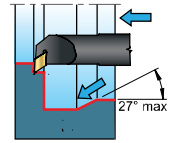
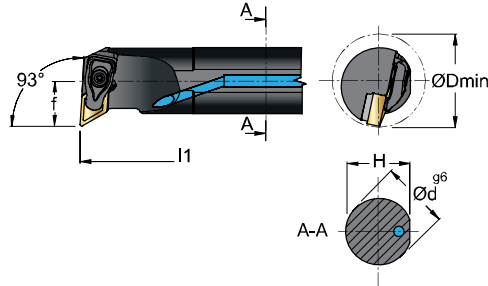



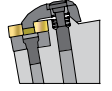

Ø32 - Ø50  
93°



**D**



Right hand holder shown

| Ordering Code |  | mm | mm    |    |    |      |     | Nm  |  |  | ①  | ②  | ③  | ④  | ⑤  |
|---------------|---|----|-------|----|----|------|-----|-----|---|---|---|--|---|---|---|
|               |   |    | ØDmin | Ød | f  | H    | l1  |     |   |   |   |  |   |   |   |
| A32S          | DDUNR/L 15  | 15 | 40    | 32 | 22 | 31,0 | 250 | 3,9 |   |   |   |  |   |   |   |
| A40T          | DDUNR/L 15  | 15 | 50    | 40 | 27 | 38,5 | 300 | 3,9 | 1506  | 100-21  | 5415  | 3715   | 125011  | 5420  |   |
| A50U          | DDUNR/L 15  | 15 | 63    | 50 | 35 | 48,0 | 350 | 3,9 |   |   |   |  |   |   |   |

Order example:  
Right hand A32S DDUNR 15  
Left hand A32S DDUNL 15

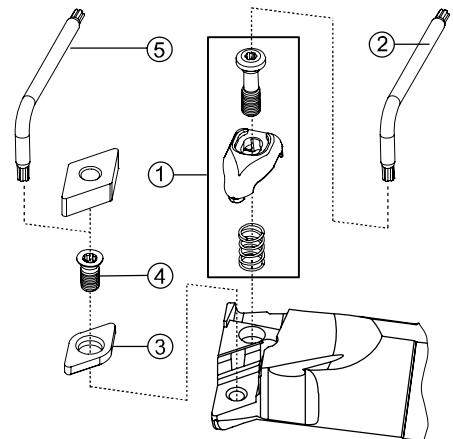





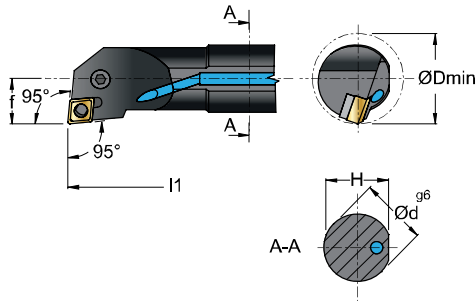



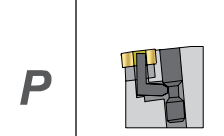
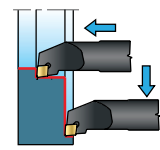

**A..PCLNR/L**

Ø20 – Ø50  
95°



Right hand holder shown



| Ordering Code |   | mm    |    |    |      |     |  | ①  | ②  | ③  | ④  | ⑤  | ⑥  |
|---------------|---|-------|----|----|------|-----|---|---|---|---|---|---|---|
|               |   | ØDmin | Ød | f  | H    | l1  |   |   |   |   |   |   |   |
| A20Q          | PCLNR/L 09  | 25    | 20 | 13 | 19,0 | 180 | 0903  | 8010  | 1605  | 5002  | -   | -   | -   |
| A25R          | PCLNR/L 09  | 32    | 25 | 17 | 24,0 | 200 | 0903  | 8410  | 1604  | 5025  | 3610  | 4108  | 0009  |
| A25R          | PCLNR/L 12  | 32    | 25 | 17 | 24,0 | 200 | 1204  | 8012  | 1648  | 5003  | 3612  | 4112  | 0012  |
| A32S          | PCLNR/L 12  | 40    | 32 | 22 | 31,0 | 250 |   |   |   |   |   |   |   |
| A40T          | PCLNR/L 12  | 50    | 40 | 27 | 38,5 | 300 | 1204  | 8012  | 1608  | 5003  | 3612  | 4112  | 0012  |
| A50U          | PCLNR/L 12  | 63    | 50 | 35 | 48,0 | 350 |   |   |   |   |   |   |   |
| A40T          | PCLNR/L 16  | 50    | 40 | 27 | 38,5 | 300 | 1606  | 8016  | 1618  | 5003  | 3616  | 4115  | 0015  |
| A50U          | PCLNR/L 16  | 63    | 50 | 35 | 48,0 | 350 |   |   |   |   |   |   |   |
| A50U          | PCLNR/L 19  | 63    | 50 | 35 | 48,0 | 350 | 1906  | 8019  | 1610  | 5004  | 3619  | 4119  | 0019  |

Order example:  
Right hand A20Q PCLNR 09  
Left hand A20Q PCLNL 09

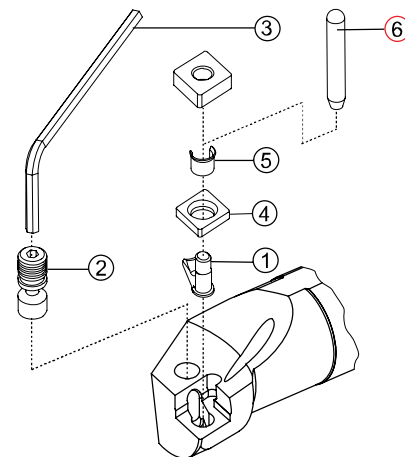

**A..PDUNR/L**

Ø20 - Ø50  
93°

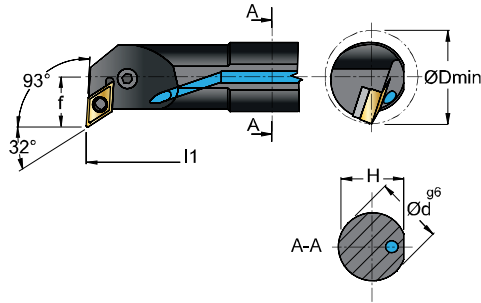

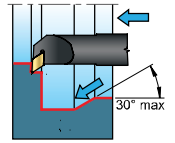

Right hand holder shown



**P**



| Ordering Code | <br> | mm    |    |    |      |     |  | ①    | ②    | ③    | ④    | ⑤    | ⑥    |
|---------------|--|-------|----|----|------|-----|---|------|------|------|------|------|------|
|               |  | ØDmin | Ød | f  | H    | l1  |   |      |      |      |      |      |      |
| A20Q          | PDUNR/L 11   | 27    | 20 | 16 | 18,0 | 180 | 1104  | 8410 | 1604 | 5025 | -    | -    | -    |
| A25R          | PDUNR/L 11   | 32    | 25 | 17 | 23,0 | 200 | 1104  | 8411 | 1606 | 5025 | 3710 | 4108 | 0009 |
| A32S          | PDUNR/L 11   | 40    | 32 | 22 | 30,0 | 250 |   |      |      |      |      |      |      |
| A32S          | PDUNR/L 15   | 40    | 32 | 22 | 31,0 | 250 |   |      |      |      |      |      |      |
| A40T          | PDUNR/L 15   | 50    | 40 | 27 | 38,5 | 300 | 1506  | 8415 | 1638 | 5003 | 3715 | 4112 | 0012 |
| A50U          | PDUNR/L 15   | 63    | 50 | 35 | 48,0 | 350 |   |      |      |      |      |      |      |

Order example:  
Right hand A20Q PDUNR 11  
Left hand A20Q PDUNL 11

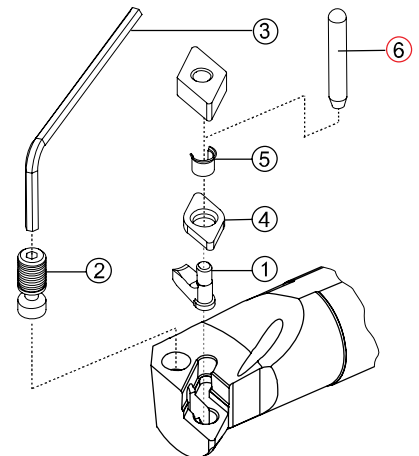

**A..PSKNR/L**

Ø25 – Ø40  
75°

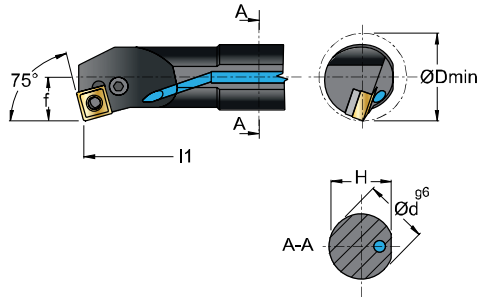



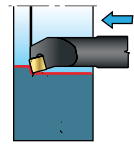





Right hand holder shown



**P**



| Ordering Code |   | mm    |    |    |      |     |  | ①  | ②  | ③  | ④  | ⑤  | ⑥  |
|---------------|---|-------|----|----|------|-----|---|---|---|---|---|---|---|
|               |   | ØDmin | Ød | f  | H    | l1  |   |   |   |   |   |   |   |
| A25R          | PSKNR/L 12  | 32    | 25 | 17 | 24,0 | 200 | 1204  | 8012  | 1648  | 5003  | 3512  | 4112  | 0012  |
| A32S          | PSKNR/L 12  | 40    | 32 | 22 | 31,0 | 250 | 1204  | 8012  | 1648  | 5003  | 3512  | 4112  | 0012  |
| A40T          | PSKNR/L 12  | 50    | 40 | 27 | 38,5 | 300 | 1204  | 8012  | 1608  | 5003  | 3512  | 4112  | 0012  |

Order example:  
Right hand A25R PSKNR 12  
Left hand A25R PSKNL 12

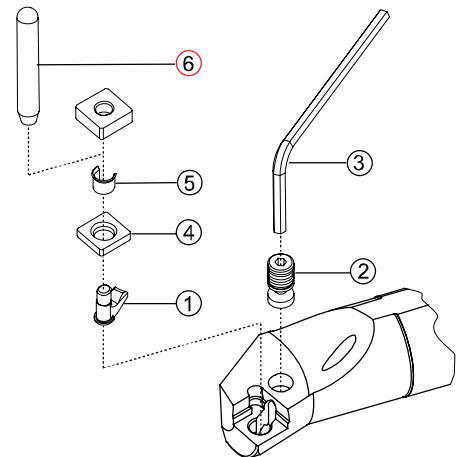



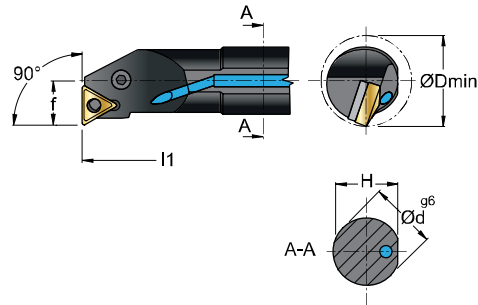

**A..PTFNR/L**



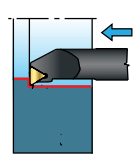





Ø16 - Ø40  
90°



Right hand holder shown



|          |   |
|----------|---|
| TNMA     |  |
| TNMG     |  |
| TNMM     |  |
| <b>P</b> |  |

| Ordering Code | <br> | mm    |    |    |       |     |  |  |  |  |  |  |  |
|---------------|--|-------|----|----|-------|-----|---|---|---|--|---|---|---|
|               |  | ØDmin | Ød | f  | H     | l1  |   |   |   |  |   |   |   |
| A16M          | PTFNR/L 11   | 21    | 16 | 11 | 15,25 | 150 | 1103  | 8008  | 1603  | 5002   | -   | -   | -   |
| A20Q          | PTFNR/L 11   | 25    | 20 | 13 | 19,0  | 180 | 1103  | 8008  | 1603  | 5002   | -   | -   | -   |
| A25R          | PTFNR/L 16   | 32    | 25 | 17 | 24,0  | 200 | 1604  | 8009  | 1606  | 5025   | 3416  | 4109  | 0009  |
| A32S          | PTFNR/L 16   | 40    | 32 | 22 | 31,0  | 250 | 1604  | 8009  | 1606  | 5025   | 3416  | 4109  | 0009  |
| A40T          | PTFNR/L 22   | 50    | 40 | 27 | 38,5  | 300 | 2204  | 8012  | 1608  | 5003   | 3422  | 4112  | 0012  |

Order example:  
Right hand A16M PTFNR 11  
Left hand A16M PTFNL 11

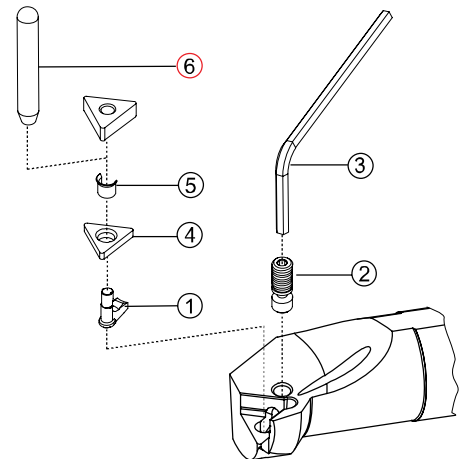

**A..PWLNR/L**

Ø16 – Ø40  
95°

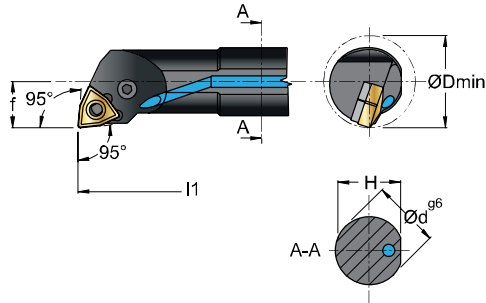



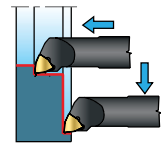





Right hand holder shown



**P**



| Ordering Code |   | mm    |    |    |       |     |  | ①  | ②  | ③  | ④  | ⑤  | ⑥  |
|---------------|---|-------|----|----|-------|-----|---|---|---|---|---|---|---|
|               |   | ØDmin | Ød | f  | H     | L1  |   |   |   |   |   |   |   |
| A16M          | PWLNR/L 06  | 21    | 16 | 11 | 15,25 | 150 | 0604  | 8216  | 1605  | 5002  | -   | -   | -   |
| A20Q          | PWLNR/L 06  | 25    | 20 | 13 | 19,0  | 180 | 0604  | 8216  | 1605  | 5002  | -   | -   | -   |
| A25R          | PWLNR/L 06  | 32    | 25 | 17 | 24,0  | 200 | 0604  | 8009  | 1606  | 5025  | 3306  | 4109  | 0009  |
| A32S          | PWLNR/L 06  | 40    | 32 | 22 | 31,0  | 250 | 0604  | 8009  | 1606  | 5025  | 3306  | 4109  | 0009  |
| A25R          | PWLNR/L 08  | 32    | 25 | 17 | 24,0  | 200 | 0804  | 8012  | 1648  | 5003  | 3308M   | 4112  | 0012  |
| A32S          | PWLNR/L 08  | 40    | 32 | 22 | 31,0  | 250 | 0804  | 8012  | 1648  | 5003  | 3308M   | 4112  | 0012  |
| A40T          | PWLNR/L 08  | 50    | 40 | 27 | 38,5  | 300 | 0804  | 8012  | 1608  | 5003  | 3308M   | 4112  | 0012  |

Order example:  
Right hand A16M PWLNR 06  
Left hand A16M PWLNL 06

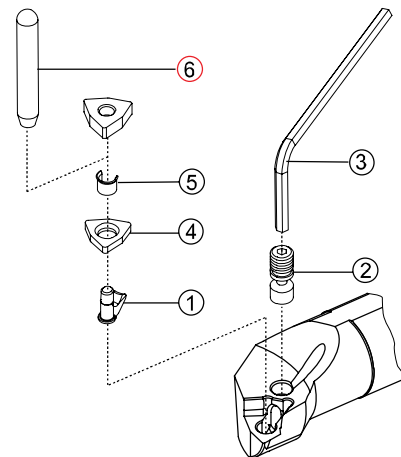







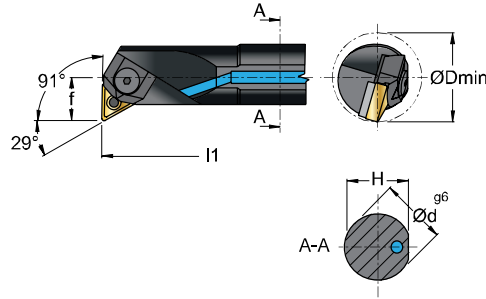





**A..MTFNR/L**

Ø25 - Ø50  
91°



Right hand holder shown

|          |   |
|----------|---|
| TNMA     |  |
| TNMG     |  |
| TNMM     |  |
| <b>M</b> |  |

| Ordering Code |  | mm    |    |    |      |     |  | ①  | ②  | ③  | ④  | ⑤  |
|---------------|---|-------|----|----|------|-----|---|---|---|---|---|---|
|               |   | ØDmin | Ød | f  | H    | l1  |   |   |   |   |   |   |
| A25R          | MTFNR/L 16  | 32    | 25 | 17 | 24,0 | 200 | 1604  | 100-50  | -   | 4187  | 100-86  | 5025  |
| A32S          | MTFNR/L 16  | 40    | 32 | 22 | 31,0 | 250 |   |   |   |   |   |   |
| A40T          | MTFNR/L 16  | 50    | 40 | 27 | 38,5 | 300 | 1604  | 100-50  | 3216  | 4188  | 100-86  | 5025  |
| A50U          | MTFNR/L 16  | 63    | 50 | 35 | 48,0 | 350 |   |   |   |   |   |   |
| A40T          | MTFNR/L 22  | 50    | 40 | 27 | 38,5 | 300 | 2204  | 100-51  | 3222  | 4190  | 100-87  | 5003  |
| A50U          | MTFNR/L 22  | 63    | 50 | 35 | 48,0 | 350 |   |   |   |   |   |   |

Order example:  
Right hand A25R MTFNR 16  
Left hand A25R MTFNL 16

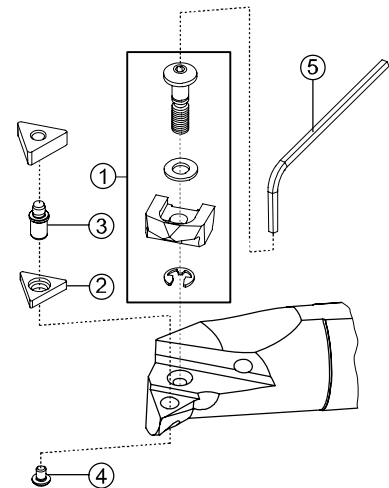

**A..MWLNR/L..N**

Ø20 – Ø50  
95°

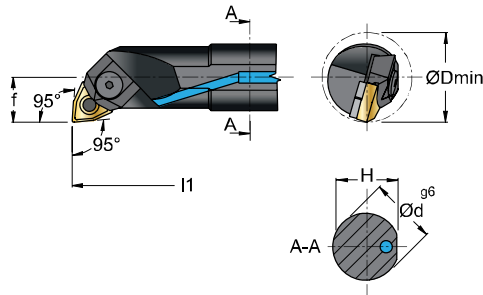

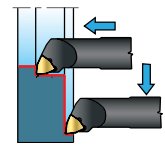

Right hand holder shown

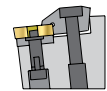

**M**



| Ordering Code |   | mm    |    |    |      |     |  | ①      | ②    | ③    | ④     | ⑤    | ⑥      |
|---------------|---|-------|----|----|------|-----|---|--------|------|------|-------|------|--------|
|               |   | ØDmin | Ød | f  | H    | l1  |   |        |      |      |       |      |        |
| A20Q          | MWLNR/L 06  | 25    | 20 | 13 | 19,0 | 180 | 0604  | 100-53 | 5510 | -    | -     | 4184 | -      |
| A25R          | MWLNR/L 06  | 32    | 25 | 17 | 24,0 | 200 | 0604  | 100-53 | 5510 | -    | 3306  | 4188 | -      |
| A32S          | MWLNR/L 06  | 40    | 32 | 22 | 31,0 | 250 |   |        |      |      |       |      |        |
| A25R          | MWLNR/L 08N   | 32    | 25 | 17 | 24,0 | 200 | 0804  | 100-52 | -    | 5025 | 3308M | 4185 | 100-87 |
| A32S          | MWLNR/L 08N   | 40    | 32 | 22 | 31,0 | 250 | 0804  | 100-52 | -    | 5025 | 3308M | 4190 | 100-87 |
| A40T          | MWLNR/L 08N   | 50    | 40 | 27 | 38,5 | 300 |   |        |      |      |       |      |        |
| S50U          | MWLNR/L 08N   | 63    | 50 | 35 | 47,0 | 350 | 0804  | 100-52 | -    | 5025 | 3308M | 4190 | 100-87 |

Order example:  
Right hand A20Q MWLNR 06  
Left hand A20Q MWLNL 06

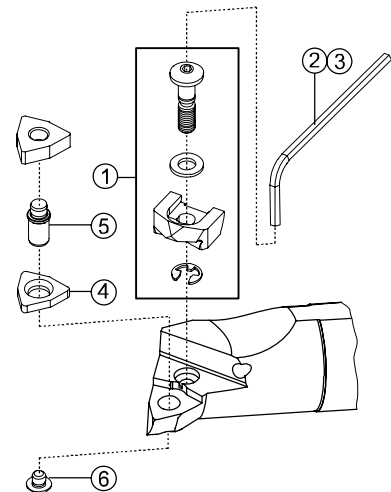

**A..MCLNR/L**

Ø25 – Ø50  
95°

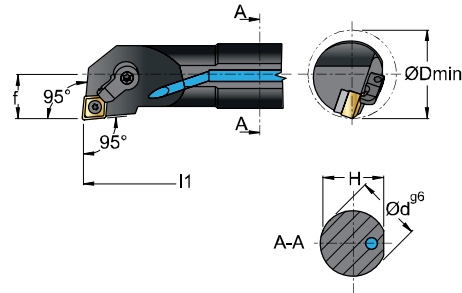

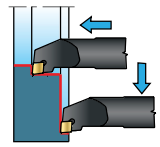

Right hand holder shown



**M**



| Ordering Code |  | mm    |    |    |      |     |  | ①       | ②      | ③      | ④       | ⑤    |
|---------------|---|-------|----|----|------|-----|---|---------|--------|--------|---------|------|
|               |   | ØDmin | Ød | f  | H    | l1  |   |         |        |        |         |      |
| A25R          | MCLNR/L 12  | 32    | 25 | 17 | 24,0 | 200 | 1204  | -       | KLM 44 | CKM 21 | STCM 20 | 5415 |
| A32S          | MCLNR/L 12  | 40    | 32 | 22 | 31,0 | 250 |   |         |        |        |         |      |
| A40T          | MCLNR/L 12  | 50    | 40 | 27 | 38,5 | 300 | 1204  | KCN 433 | KLM 46 | CKM 21 | STCM 20 | 5415 |
| A50U          | MCLNR/L 12  | 63    | 50 | 35 | 48,0 | 350 |   |         |        |        |         |      |
| A40T          | MCLNR/L 16  | 50    | 40 | 27 | 38,5 | 300 | 1606  | KCN 533 | KLM 58 | CKM 21 | STCM 20 | 5415 |
| A50U          | MCLNR/L 16  | 63    | 50 | 35 | 48,0 | 350 |   |         |        |        |         |      |
| A50U          | MCLNR/L 19  | 63    | 50 | 35 | 48,0 | 350 | 1906  | KCN 633 | KLM 68 | CKM 12 | STCM 4  | 5425 |

Order example:  
Right hand A25R MCLNR 12  
Left hand A25R MCLNL 12

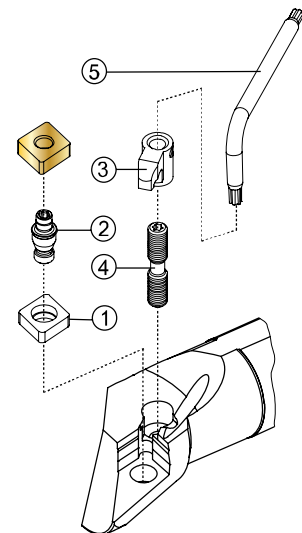

**A..MDUNR/L**

Ø25 – Ø40  
93°

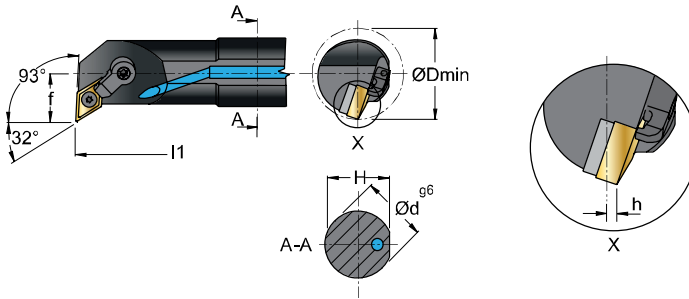



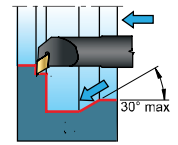





Right hand holder shown



**M**



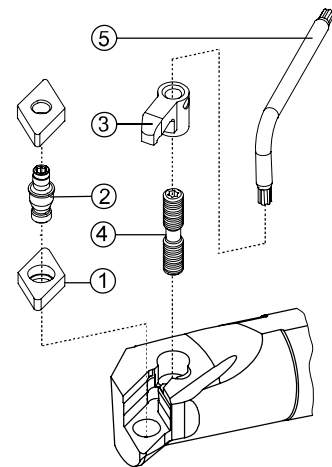

| Ordering Code |   | mm    |    |    |      |     |     |  | ①  | ②  | ③  | ④  | ⑤  |
|---------------|---|-------|----|----|------|-----|-----|---|---|---|---|---|---|
|               |   | ØDmin | Ød | f  | H    | l1  | h   |   |   |   |   |   |   |
| A25R          | MDUNR/L 15  | 32    | 25 | 17 | 24,0 | 200 | 1,5 | 1506  | KDN433  | KLM 46  | CKM 22  | STCM20  | 5415  |
| A32S          | MDUNR/L 15  | 40    | 32 | 22 | 31,0 | 250 | 1,5 |   |   |   |   |   |   |
| A40T          | MDUNR/L 15  | 50    | 40 | 27 | 38,5 | 300 | 0   |   |   |   |   |   |   |

Order example:  
Right hand A25R MDUNR 15  
Left hand A25R MDUNL 15

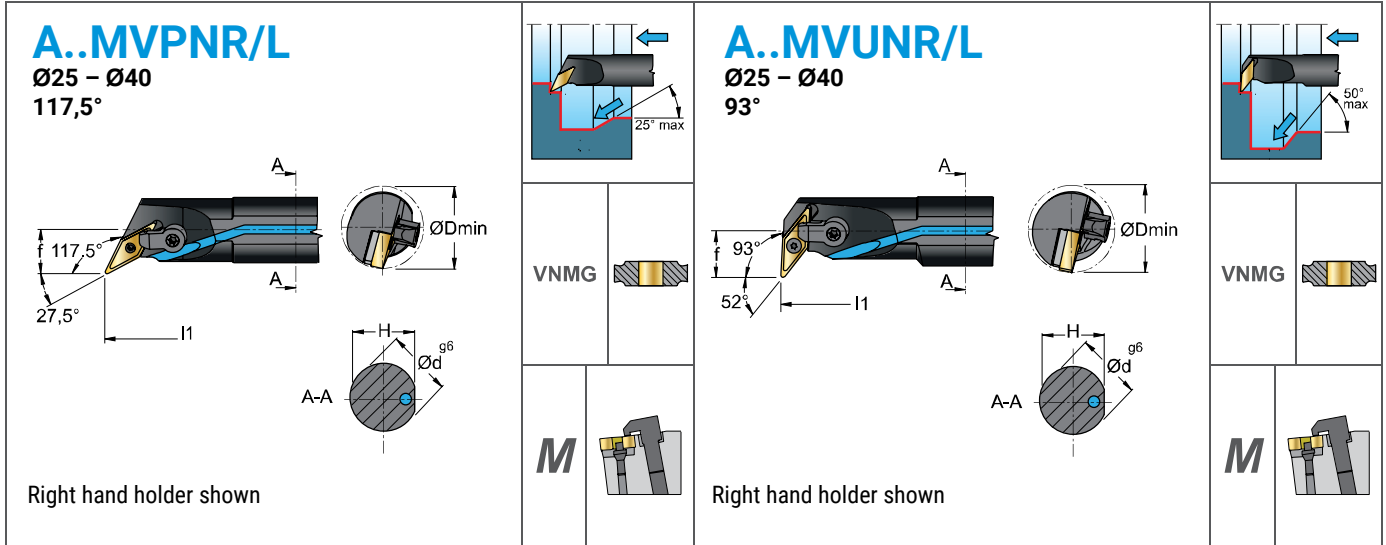



| Ordering Code |  | mm    |    |    |      |     |  | ①      | ②      | ③    | ④     | ⑤      | ⑥    |
|---------------|---|-------|----|----|------|-----|---|--------|--------|------|-------|--------|------|
|               |   | ØDmin | Ød | f  | H    | l1  |   |        |        |      |       |        |      |
| A25R          | MVPNR/L 16  | 32    | 25 | 17 | 24,0 | 200 | 1604  | KVN323 | KLM34L | 5508 | CKM21 | STCM25 | 5415 |
| A32S          | MVPNR/L 16  | 40    | 32 | 22 | 31,0 | 250 | 1604  | KVN323 | KLM34L | 5508 | CKM22 | STCM25 | 5415 |
| A40T          | MVPNR/L 16  | 50    | 40 | 27 | 38,5 | 300 | 1604  | KVN323 | KLM34L | 5508 | CKM22 | STCM20 | 5415 |
| A25R          | MVUNR/L 16  | 32    | 25 | 17 | 24,0 | 200 | 1604  | KVN323 | KLM34L | 5508 | CKM21 | STCM25 | 5415 |
| A32S          | MVUNR/L 16  | 40    | 32 | 22 | 31,0 | 250 |   |        |        |      |       |        |      |
| A40T          | MVUNR/L 16  | 50    | 40 | 27 | 38,5 | 300 |   |        |        |      |       |        |      |

Order example:  
Right hand A25R MVPNR 16  
Left hand A25R MVPNL 16

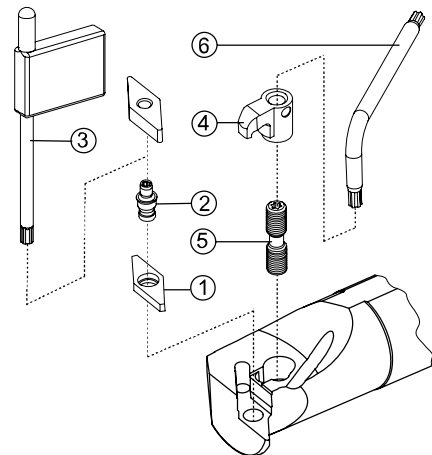

**A..MVZNR/L**

Ø32 – Ø40  
95°

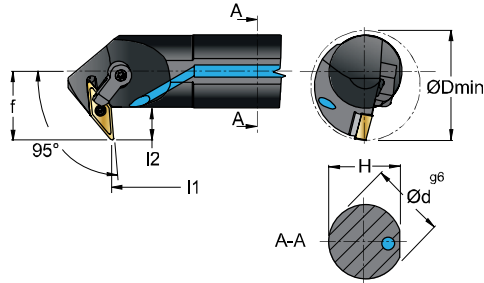

Right hand holder shown

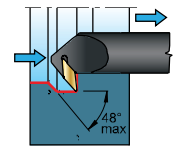









VNMG



**M**



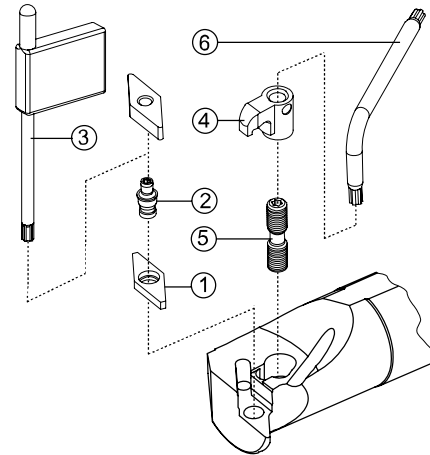

| Ordering Code |  | mm    |    |    |      |     |    |      |  | ①   | ②   | ③   | ④   | ⑤   | ⑥    |
|---------------|---|-------|----|----|------|-----|----|------|---|---|---|---|---|---|------|
|               |   | ØDmin | Ød | f  | H    | l1  | l2 |      |   |   |   |   |   |   |      |
| A32S          | MVZNR/L 16  | 48    | 32 | 30 | 31,0 | 250 | 14 | 1604 |  |  |  |  |  |  | 5415 |
| A40T          | MVZNR/L 16  | 57    | 40 | 35 | 38,5 | 300 | 15 |      |   |   |   |   |   |   |      |

Order example:  
Right hand A32S MVZNR 16  
Left hand A32S MVZNL 16

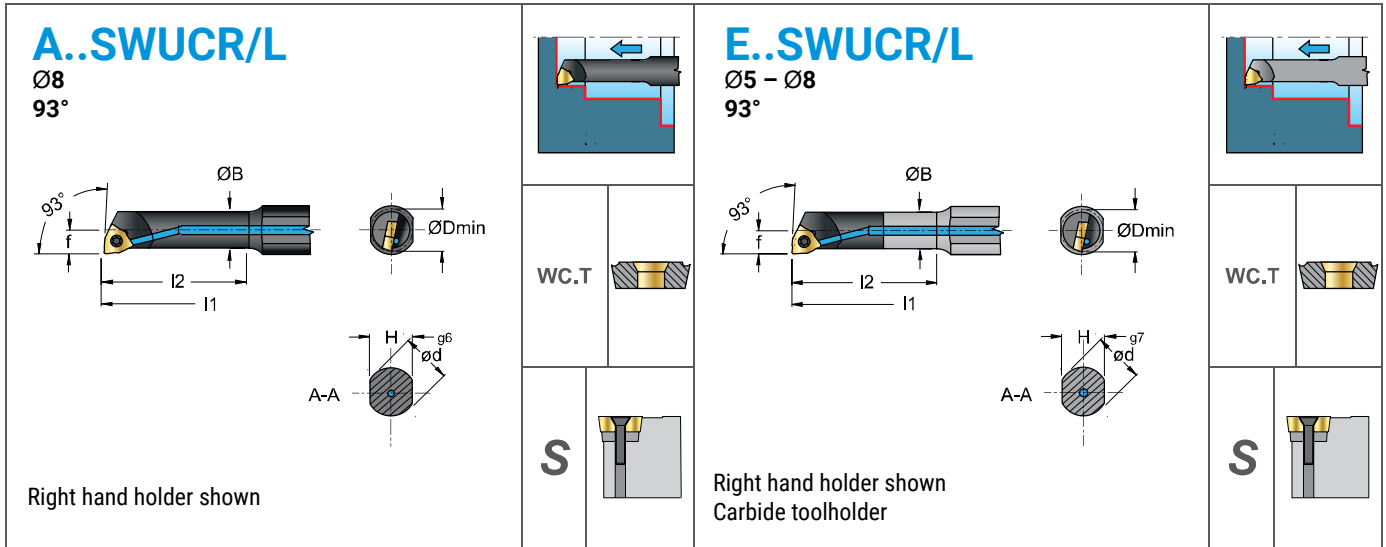





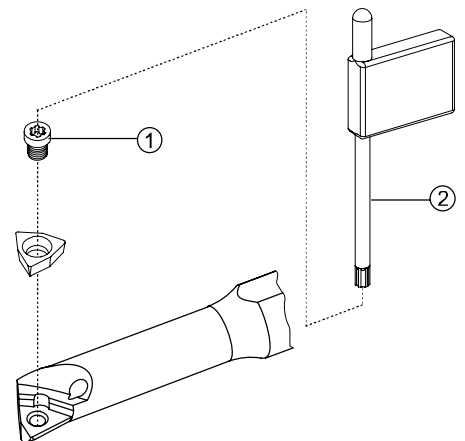

| Ordering Code |  | mm    |    |    |     |   |     |    |         | <br>Nm |  | ①    | ② |
|---------------|---|-------|----|----|-----|---|-----|----|---------|---|---|------|---|
|               |   | ØDmin | Ød | ØB | f   | H | l1  | l2 |         |   |   |      |   |
| A0508H        | SWUCR/L 02  | 5,8   | 8  | 5  | 2,9 | 7 | 100 | 16 | 0,5-0,6 | 0201  | 12203   | 5506 |   |
| A0608H        | SWUCR/L 02  | 7,8   | 8  | 6  | 3,9 | 7 | 100 | 24 | 0,5-0,6 |   |   |      |   |
| E05F          | SWUCR/L 02  | 5,8   | 5  | 5  | 2,9 | - | 85  | -  | 0,5-0,6 | 0201  | 12203   | 5506 |   |
| E06G          | SWUCR/L 02  | 7,8   | 6  | 6  | 3,9 | - | 95  | -  | 0,5-0,6 |   |   |      |   |
| E0508H        | SWUCR/L 02  | 5,8   | 8  | 5  | 2,9 | 7 | 100 | 24 | 0,5-0,6 | 0201  | 12203   | 5506 |   |
| E0608H        | SWUCR/L 02  | 7,8   | 8  | 6  | 3,9 | 7 | 100 | 30 | 0,5-0,6 |   |   |      |   |

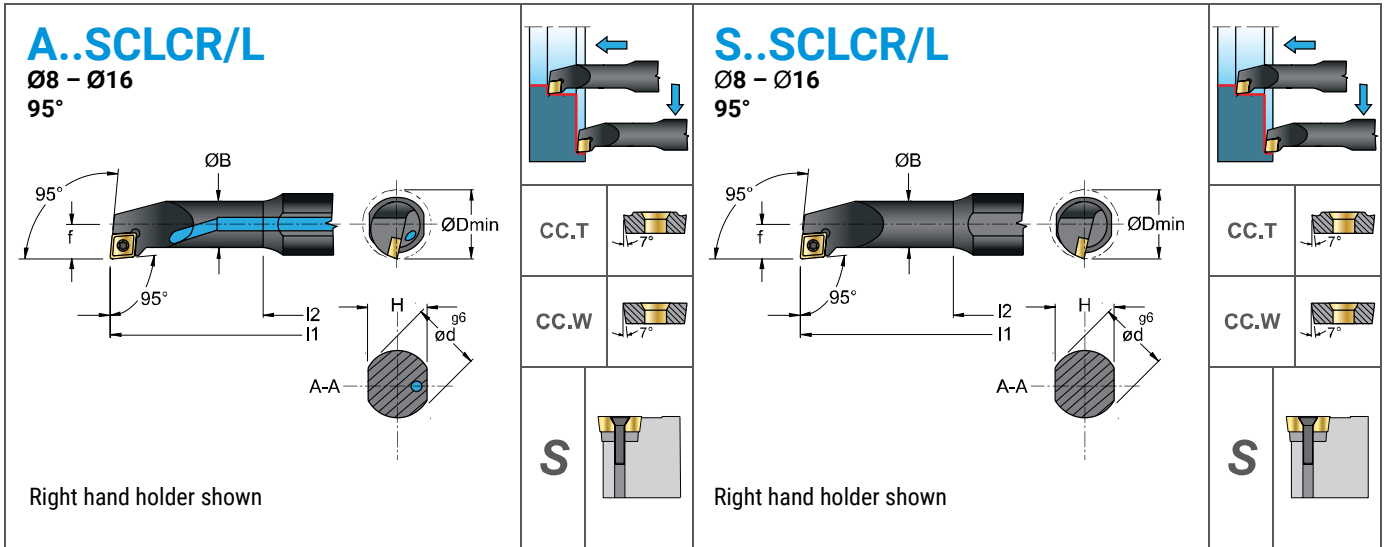
Order example:  
Right hand A0508H SWUCR 02  
Left hand A0508H SWUCL 02





| Ordering Code |  | mm    |    |    |   |    |     |    |         | <br>Nm |  | ①<br> | ②<br> |
|---------------|---|-------|----|----|---|----|-----|----|---------|---|---|--|--|
|               |   | ØDmin | Ød | ØB | f | H  | l1  | l2 |         |   |   |  |  |
| A0608H        | SCLCR/L 06  | 8,5   | 8  | 6  | 4 | 7  | 100 | 20 | 1,0÷1,2 | 0602  | 12254P  | 5507P  |  |
| A0810J        | SCLCR/L 06  | 10,5  | 10 | 8  | 6 | 9  | 110 | 26 | 1,0÷1,2 |   |   |  |  |
| A1012K        | SCLCR/L 06  | 12,5  | 12 | 10 | 7 | 11 | 125 | 32 | 1,0÷1,2 |   |   |  |  |
| A1216M        | SCLCR/L 06  | 15,5  | 16 | 12 | 9 | 15 | 150 | 40 | 1,0÷1,2 |   |   |  |  |
| S0608H        | SCLCR/L 06  | 8,5   | 8  | 6  | 4 | 7  | 100 | 20 | 1,0÷1,2 | 0602  | 12254P  | 5507P  |  |
| S0810J        | SCLCR/L 06  | 10,5  | 10 | 8  | 6 | 9  | 110 | 26 | 1,0÷1,2 |   |   |  |  |
| S1012K        | SCLCR/L 06  | 12,5  | 12 | 10 | 7 | 11 | 125 | 32 | 1,0÷1,2 |   |   |  |  |
| S1216M        | SCLCR/L 06  | 15,5  | 16 | 12 | 9 | 15 | 150 | 40 | 1,0÷1,2 |   |   |  |  |

Order example:  
Right hand A0608H SCLCR 06  
Left hand A0608H SCLCL 06

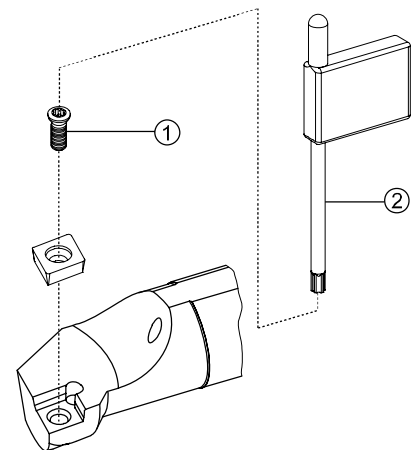





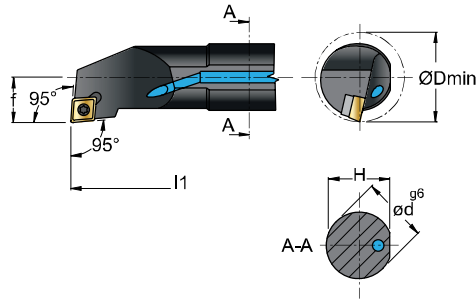

**A..SCLCR/L**

Ø8 – Ø40  
95°

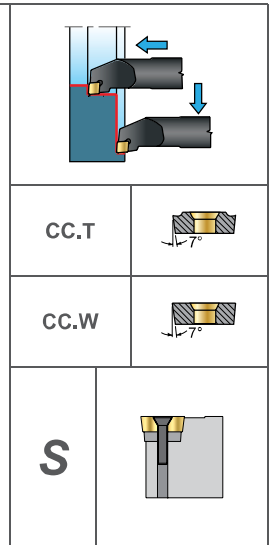

Right hand holder shown



| Ordering Code         |  | mm    |    |      |       |     | <br>Nm |  | ①    | ②     | ③         | ④     |
|-----------------------|---|-------|----|------|-------|-----|---|---|------|-------|-----------|-------|
|                       |   | ØDmin | Ød | f    | H     | l1  |   |   |      |       |           |       |
| A08F                  | SCLCR/L 06  | 10    | 8  | 5    | 7,60  | 80  | 1,0÷1,2   | 0602  | -    | -     | 12254P    | 5507P |
| A10H                  | SCLCR/L 06  | 12    | 10 | 7    | 9,50  | 100 | 1,1÷1,3   | 0602  | -    | -     | 12256P    | 5508P |
| A12K                  | SCLCR/L 06  | 16    | 12 | 9    | 11,50 | 125 | 1,1÷1,3   |   |      |       |           |       |
| A16M                  | SCLCR/L 09  | 20    | 16 | 11   | 15,25 | 150 | 3,8÷5,0   | 09T3  | -    | -     | 12409P    | 5515P |
| A20Q                  | SCLCR/L 09  | 25    | 20 | 13   | 19,00 | 180 | 3,8÷5,0   | 09T3  | -    | -     | 1240P     | 5515P |
| A25R                  | SCLCR/L 12  | 32    | 25 | 17   | 24,00 | 200 | 4,0÷5,0   | 1204  | -    | -     | 124510    | 5520  |
| A32S                  | SCLCR/L 12  | 40    | 32 | 22   | 31,00 | 250 | 4,0÷5,0   | 1204  | 3611 | BCL15 | 124513P   | 5520P |
| A40T                  | SCLCR/L 12  | 50    | 40 | 27   | 38,50 | 300 | 4,0÷5,0   |   |      |       |           |       |
| <b>HSS toolholder</b> |   |       |    |      |       |     |   |   |      |       |           |       |
| AH08K                 | SCLCR/L 06  | 10    | 8  | 5    | 7,0   | 125 | 1,0÷1,2   | 0602  | -    | -     | BFTX02506 | TRX08 |
| AH10K                 | SCLCR/L 06  | 12    | 10 | 6    | 9,0   | 125 | 1,0÷1,2   | 0602  | -    | -     | BFTX02506 | TRX08 |
| AH12M                 | SCLCR/L 06  | 14    | 12 | 7    | 11,0  | 150 | 1,0÷1,3   | 0602  | -    | -     | BFTX02506 | TRX08 |
| AH12M                 | SCLCR/L 09  | 14    | 12 | 9    | 11,0  | 150 | 3,8÷5,0   | 09T3  | -    | -     | BFTX0407  | TRX15 |
| AH16Q                 | SCLCR/L 09  | 18    | 16 | 11   | 14,0  | 180 | 3,8÷5,0   | 09T3  | -    | -     | BFTX0407  | TRX15 |
| AH20R                 | SCLCR/L 09  | 23    | 20 | 13   | 18,0  | 200 | 3,8÷5,0   | 09T3  | -    | -     | BFTX0407  | TRX15 |
| AH25R                 | SCLCR/L 09  | 28    | 25 | 15,5 | 23,0  | 200 | 3,8÷5,0   | 09T3  | -    | -     | BFTX0407  | TRX15 |
| AH25R                 | SCLCR/L 12  | 28    | 25 | 15,5 | 23,0  | 200 | 4,0÷5,0   | 1204  | -    | -     | BFTX0511  | TRX15 |

Order example:  
Right hand A08F SCLCR 06  
Left hand A08F SCLCL 06

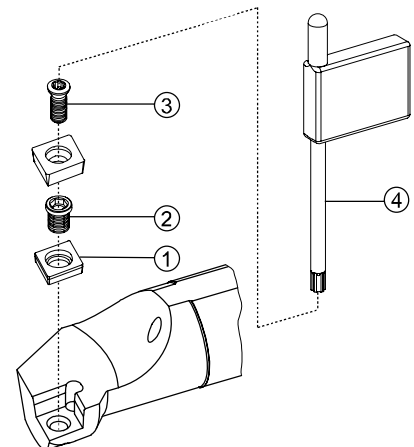

**E..SCLCR/L**

Ø8 – Ø25  
95°

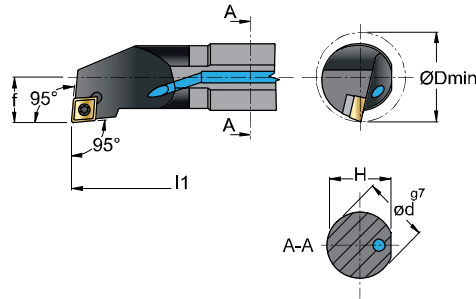

Right hand holder shown  
Carbide toolholder

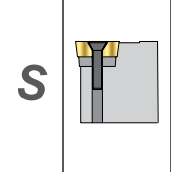
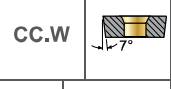
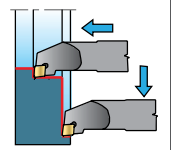

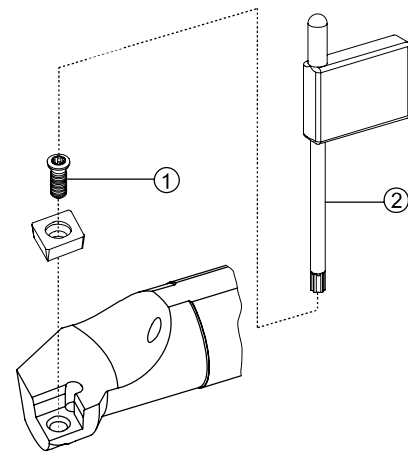

| Ordering Code |  | mm    |    |    |       |     | <br>Nm |  | ①      | ②     |
|---------------|---|-------|----|----|-------|-----|---|--|--------|-------|
|               |   | ØDmin | Ød | f  | H     | l1  |   |  |        |       |
| E08K          | SCLCR/L 06  | 11    | 8  | 5  | 7,60  | 125 | 1,0÷1,2   | 0602   | 12254P | 5507P |
| E10K          | SCLCR/L 06  | 13    | 10 | 7  | 9,50  | 125 | 1,1÷1,3   | 0602   | 12256P | 5508P |
| E12M          | SCLCR/L 06  | 16    | 12 | 9  | 11,50 | 150 | 1,1÷1,3   |  |        |       |
| E16R          | SCLCR/L 09  | 20    | 16 | 11 | 15,25 | 200 | 3,8÷5,0   | 09T3   | 12409P | 5515P |
| E20S          | SCLCR/L 09  | 25    | 20 | 13 | 19,00 | 250 | 3,8÷5,0   |  |        |       |
| E25T          | SCLCR/L 09  | 32    | 25 | 17 | 24,00 | 300 | 3,8÷5,0   |  |        |       |

Order example:  
Right hand E08K SCLCR 06  
Left hand E08K SCLCL 06

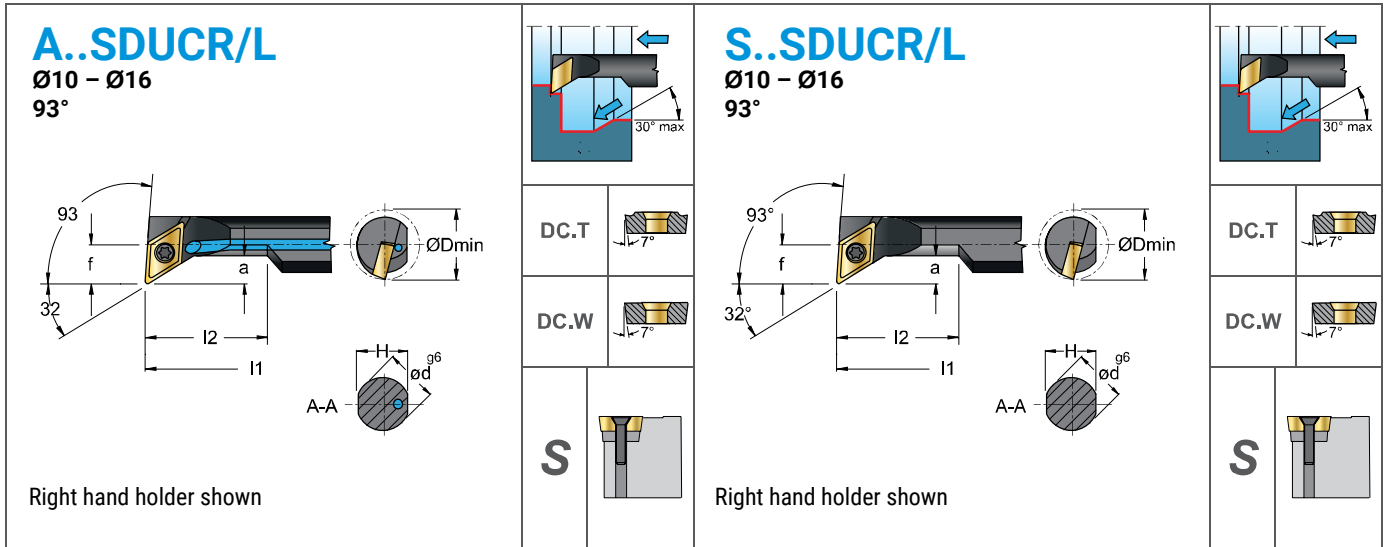



| Ordering Code |  | mm    |    |    |   |    |     |    | <br>Nm |  | ①<br> | ②<br> |
|---------------|---|-------|----|----|---|----|-----|----|---|---|--|--|
|               |   | ØDmin | Ød | f  | a | H  | l1  | l2 |   |   |  |  |
| <b>A0810H</b> | SDUCR/L 07  | 12,5  | 10 | 7  | 4 | 9  | 100 | 22 | 1,0±1,2   |   |  |  |
| <b>A1012K</b> | SDUCR/L 07  | 15,5  | 12 | 9  | 5 | 11 | 125 | 28 | 1,0±1,2   | 0702  | 12254P   | 5507P  |
| <b>A1216M</b> | SDUCR/L 07  | 19,5  | 16 | 11 | 5 | 15 | 150 | 36 | 1,0±1,2   |   |  |  |
| <b>S0810H</b> | SDUCR/L 07  | 12,5  | 10 | 7  | 4 | 9  | 100 | 22 | 1,0±1,2   |   |  |  |
| <b>S1012K</b> | SDUCR/L 07  | 15,5  | 12 | 9  | 5 | 11 | 125 | 28 | 1,0±1,2   | 0702  | 12254P   | 5507P  |
| <b>S1216M</b> | SDUCR/L 07  | 19,5  | 16 | 11 | 5 | 15 | 150 | 36 | 1,0±1,2   |   |  |  |

Order example:  
Right hand A0810H SDUCR 07  
Left hand A0810H SDUCL 07

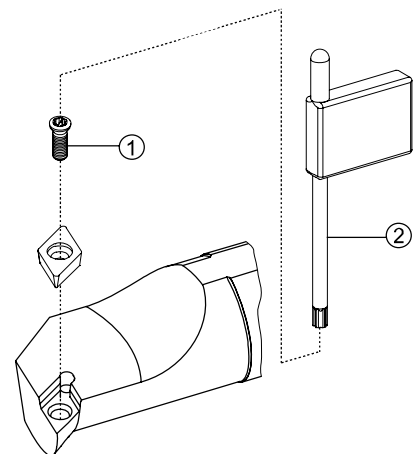

**A..SDUCR/L**

**Ø10 – Ø40**  
**93°**

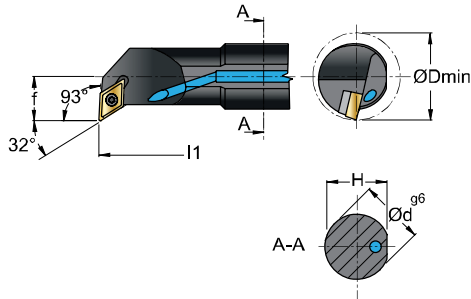

Right hand holder shown

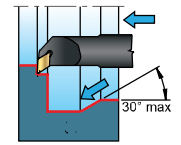

DC.T





DC.W



S



| Ordering Code         |  | mm    |    |      |       |     | <br>Nm |  | ①    | ②         | ③       | ④     |
|-----------------------|---|-------|----|------|-------|-----|---|---|------|-----------|---------|-------|
|                       |   | ØDmin | Ød | f    | H     | l1  |   |   |      |           |         |       |
| A10H                  | SDUCR/L 07  | 13    | 10 | 8    | 9,50  | 100 | 1,1÷1,3   | 0702  | -    | -         | 12256P  | 5508P |
| A12K                  | SDUCR/L 07  | 16    | 12 | 9    | 11,50 | 125 | 1,1÷1,3   |   |      |           |         |       |
| A16M                  | SDUCR/L 07  | 20    | 16 | 11   | 15,25 | 150 | 1,1÷1,3   |   | -    | -         | 12409P  | 5515P |
| A20Q                  | SDUCR/L 07  | 25    | 20 | 13   | 19,00 | 180 | 1,1÷1,3   |   | -    | -         | 1240P   | 5515P |
| A20Q                  | SDUCR/L 11  | 25    | 20 | 13   | 19,00 | 180 | 3,8÷5,0   | 11T3  | 3711 | BCL7      | 123511P | 5515P |
| A25R                  | SDUCR/L 11  | 32    | 25 | 17   | 24,00 | 200 | 3,8÷5,0   | 11T3  |      |           |         |       |
| A32S                  | SDUCR/L 11  | 40    | 32 | 22   | 31,00 | 250 | 3,0÷3,5   | 11T3  |      |           |         |       |
| A40T                  | SDUCR/L 11  | 49    | 40 | 27   | 38,50 | 300 | 3,0÷3,5   |   |      |           |         |       |
| <b>HSS toolholder</b> |   |       |    |      |       |     |   |   |      |           |         |       |
| AH10K                 | SDUCR/L 07  | 14    | 10 | 8.3  | 9.0   | 125 | 1,1÷1,3   | 0702  | -    | BFTX02506 | TRX08   | TRX08 |
| AH12M                 | SDUCR/L 07  | 16    | 12 | 9.3  | 11.0  | 150 | 1,1÷1,3   | 0702  | -    | BFTX02506 | TRX08   | TRX08 |
| AH16Q                 | SDUCR/L 07  | 20    | 16 | 11.3 | 14.0  | 180 | 1,1÷1,3   | 0702  | -    | BFTX02506 | TRX08   | TRX08 |
| AH20R                 | SDUCR/L 11  | 26    | 20 | 16.1 | 18.0  | 200 | 3,8÷5,0   | 11T3  | -    | BFTX0407  | TRX15   | TRX15 |
| AH25R                 | SDUCR/L 11  | 32    | 25 | 18.6 | 23.0  | 200 | 3,8÷5,0   | 11T3  | -    | BFTX0407  | TRX15   | TRX15 |

**Order example:**  
Right hand A10H SDUCR 07  
Left hand A10H SDUCL 07

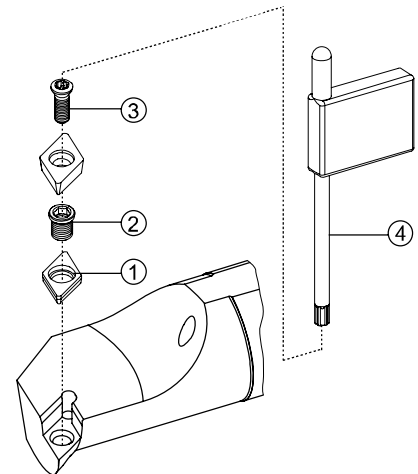





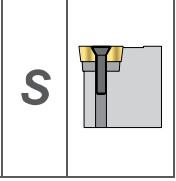
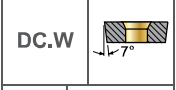
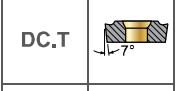
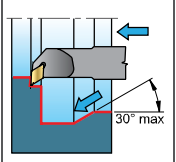
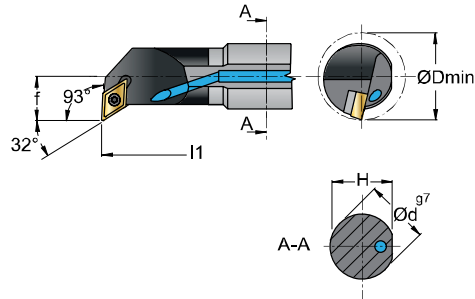

**E..SDUCR/L**

Ø10 – Ø20  
93°





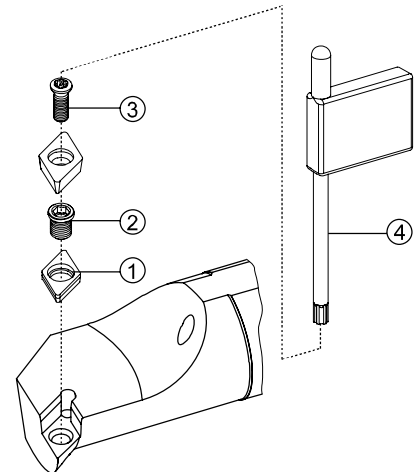

Right hand holder shown  
Carbide toolholder

| Ordering Code |  | mm    |    |    |       |     | <br>Nm |  | ①  | ②  | ③  | ④  |
|---------------|---|-------|----|----|-------|-----|---|---|--|---|---|---|
|               |   | ØDmin | Ød | f  | H     | l1  |   |   |  |   |   |   |
| E10K          | SDUCR/L 07  | 12    | 10 | 7  | 9,50  | 125 | 1,1÷1,3   |   |  |   |   |   |
| E12M          | SDUCR/L 07  | 16    | 12 | 9  | 11,50 | 150 | 1,1÷1,3   | 0702  | -  | -   | 12256P  | 5508P   |
| E16R          | SDUCR/L 07  | 20    | 16 | 11 | 15,25 | 200 | 1,1÷1,3   |   |  |   |   |   |
| E20S          | SDUCR/L 11  | 25    | 20 | 13 | 19,00 | 250 | 3,8÷5,0   | 11T3  | -  | -   | 12409P  | 5515P   |

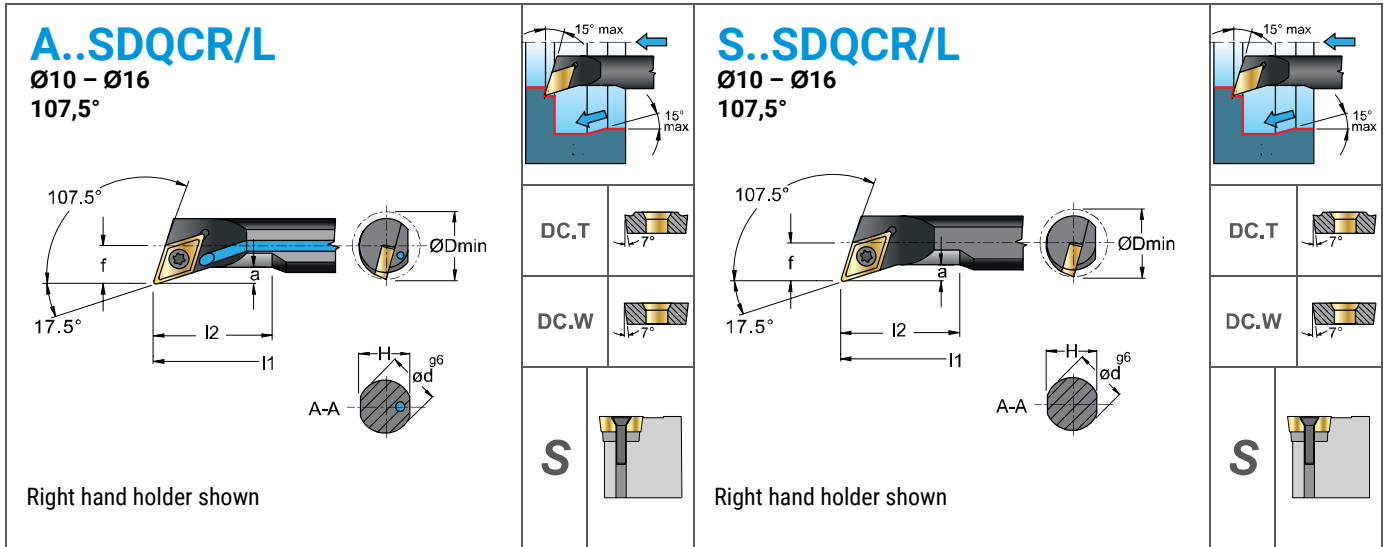
Order example:  
Right hand E10K SDUCR 07  
Left hand E10K SDUCL 07





| Ordering Code |  | mm    |    |    |   |    |     |    | <br>Nm |  | ①      | ②     |
|---------------|---|-------|----|----|---|----|-----|----|---|---|--------|-------|
|               |   | ØDmin | Ød | f  | a | H  | l1  | l2 |   |   |        |       |
| A0810H        | SDQCR/L 07  | 12,5  | 10 | 7  | 3 | 9  | 100 | 22 | 1,0÷1,2   |   |        |       |
| A1012K        | SDQCR/L 07  | 15,5  | 12 | 9  | 4 | 11 | 125 | 28 | 1,0÷1,2   | 0702  | 12254P | 5507P |
| A1216M        | SDQCR/L 07  | 19,5  | 16 | 11 | 5 | 15 | 150 | 36 | 1,0÷1,2   |   |        |       |
| S0810H        | SDQCR/L 07  | 12,5  | 10 | 7  | 3 | 9  | 100 | 22 | 1,0÷1,2   |   |        |       |
| S1012K        | SDQCR/L 07  | 15,5  | 12 | 9  | 4 | 11 | 125 | 28 | 1,0÷1,2   | 0702  | 12254P | 5507P |
| S1216M        | SDQCR/L 07  | 19,5  | 16 | 11 | 5 | 15 | 150 | 36 | 1,0÷1,2   |   |        |       |

**Order example:**  
Right hand A0810H SDQCR 07  
Left hand A0810H SDQCL 07

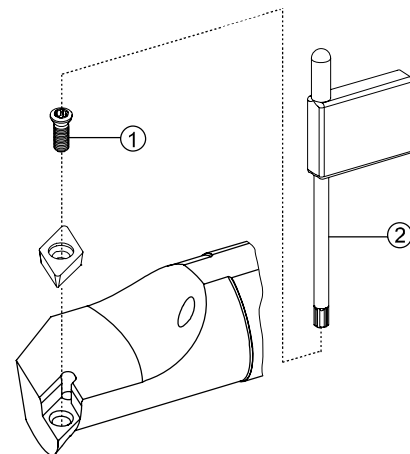

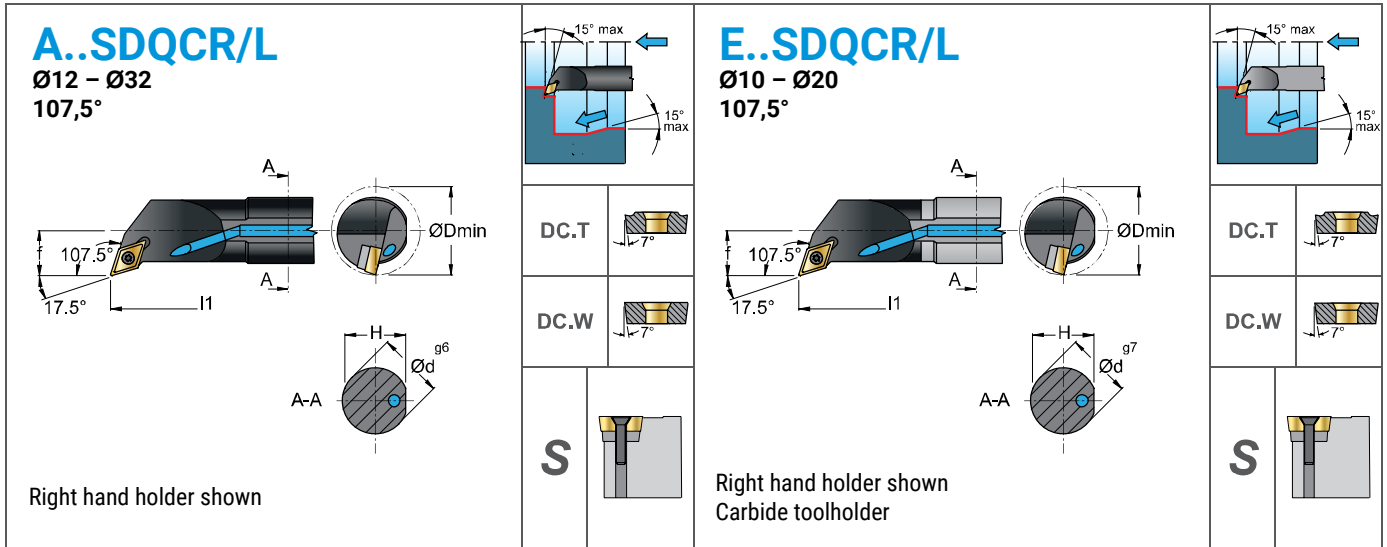

| Ordering Code |  | mm    |    |    |       |     | <br>Nm |  | ①    | ②    | ③       | ④     |
|---------------|---|-------|----|----|-------|-----|---|---|------|------|---------|-------|
|               |   | ØDmin | Ød | f  | H     | l1  |   |   |      |      |         |       |
| A12K          | SDQCR/L 07  | 16    | 12 | 9  | 11,50 | 125 | 1,1÷1,3   | 0702  | -    | -    | 12256P  | 5508P |
| A16M          | SDQCR/L 07  | 20    | 16 | 11 | 15,25 | 150 | 1,1÷1,3   |   |      |      |         |       |
| A20Q          | SDQCR/L 07  | 25    | 20 | 13 | 19,00 | 180 | 1,1÷1,3   |   |      |      |         |       |
| A20Q          | SDQCR/L 11  | 25    | 20 | 13 | 19,00 | 180 | 3,8÷5,0   | 11T3  | -    | -    | 12409P  | 5515P |
| A25R          | SDQCR/L 11  | 32    | 25 | 17 | 24,00 | 200 | 3,8÷5,0   | 11T3  | -    | -    | 1240P   | 5515P |
| A32S          | SDQCR/L 11  | 40    | 32 | 22 | 31,00 | 250 | 3,0÷3,5   | 11T3  | 3711 | BCL7 | 123511P | 5515P |
| E10K          | SDQCR/L 07  | 12    | 10 | 7  | 9     | 125 | 1,1÷1,3   | 0702  | -    | -    | 12256P  | 5508P |
| E12M          | SDQCR/L 07  | 15    | 12 | 9  | 11    | 150 | 1,1÷1,3   |   |      |      |         |       |
| E16R          | SDQCR/L 07  | 19    | 16 | 11 | 15    | 200 | 1,1÷1,3   |   |      |      |         |       |
| E20S          | SDQCR/L 11  | 23    | 20 | 13 | 18    | 250 | 3,8÷5,0   | 11T3  | -    | -    | 12409P  | 5515P |

Order example:  
Right hand A12K SDQCR 07  
Left hand A12K SDQCL 07

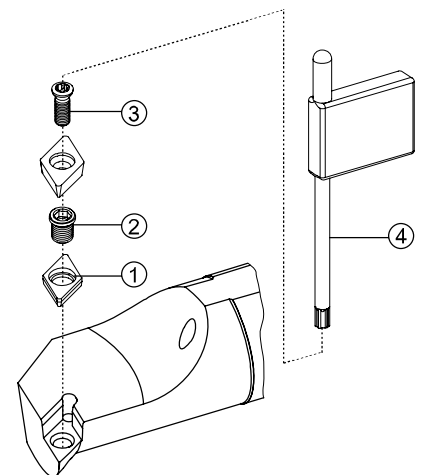

**A..SDNCR/L**

Ø15 – Ø25  
63°

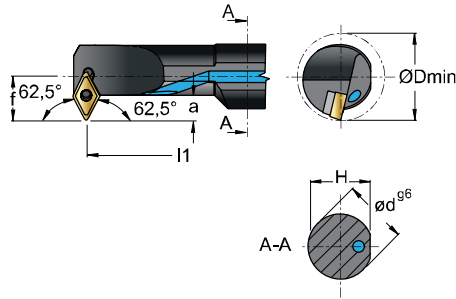

Right hand holder shown

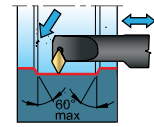

DC.T







DC.W



**S**



| Ordering Code |  | mm    |    |    |   |       |     | <br>Nm |  | ①<br> | ②<br> |
|---------------|---|-------|----|----|---|-------|-----|---|--|--|--|
|               |   | ØDmin | Ød | f  | a | H     | l1  |   |  |  |  |
| A16M          | SDNCR/L 07  | 20    | 16 | 11 | 6 | 15,25 | 150 | 1,1÷1,3   | 0702   | 12256P   | 5508P  |
| A20Q          | SDNCR/L 11  | 25    | 20 | 15 | 9 | 19,00 | 180 | 3,8÷5,0   | 11T3   | 12409P   | 5515P  |
| A25R          | SDNCR/L 11  | 32    | 25 | 17 | 9 | 24,00 | 200 | 3,8÷5,0   | 11T3   | 1240P  | 5515P  |

Order example:  
Right hand A16M SDNCR 07  
Left hand A16M SDNCL 07

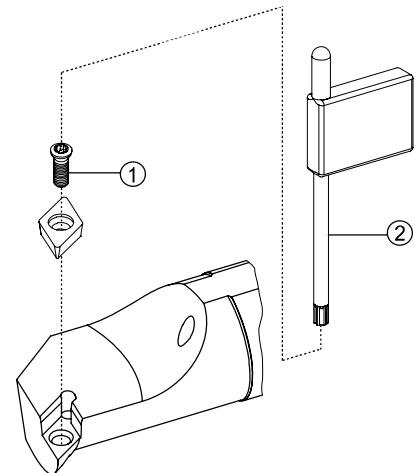





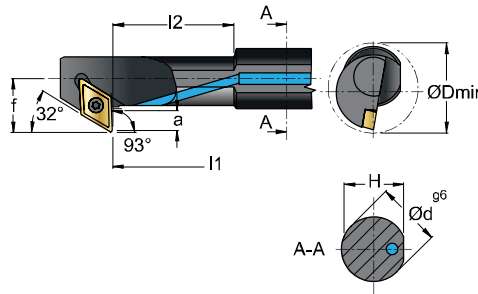

**A..SDXCR/L**  
Ø12 – Ø25  
93°

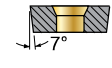
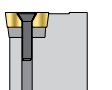

Right hand holder shown

|      |   |
|------|---|
| DC.T |  |
| DC.W |  |
| S    |  |

| Ordering Code |  | mm    |    |      |     |       |     |    |         | <br>Nm |  | ①<br> | ②<br> |
|---------------|---|-------|----|------|-----|-------|-----|----|---------|---|---|--|--|
|               |   | ØDmin | Ød | f    | a   | H     | l1  | l2 |         |   |   |  |  |
| A12K          | SDXCR/L 07  | 16    | 12 | 11,0 | 5,0 | 11,50 | 125 | 25 | 1,1÷1,3 | 0702  | 12256P  | 5508P  |  |
| A16M          | SDXCR/L 07  | 20    | 16 | 13,0 | 5,0 | 15,25 | 150 | 35 | 1,1÷1,3 |   |   |  |  |
| A20Q          | SDXCR/L 11  | 25    | 20 | 16,5 | 6,5 | 19,00 | 180 | 40 | 3,8÷5,0 | 11T3  | 12409P  | 5515P  |  |
| A25R          | SDXCR/L 11  | 32    | 25 | 19,0 | 6,5 | 24,00 | 200 | 50 | 3,8÷5,0 |   |   |  |  |

Order example:  
Right hand A12K SDXCR 07  
Left hand A12K SDXCL 07

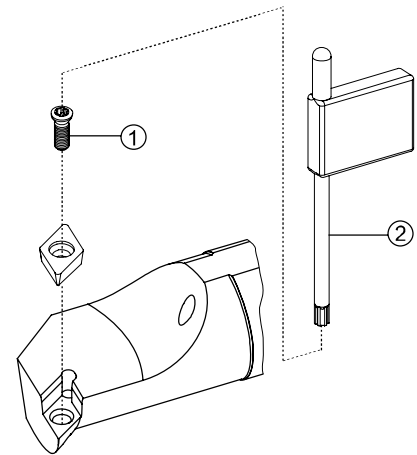

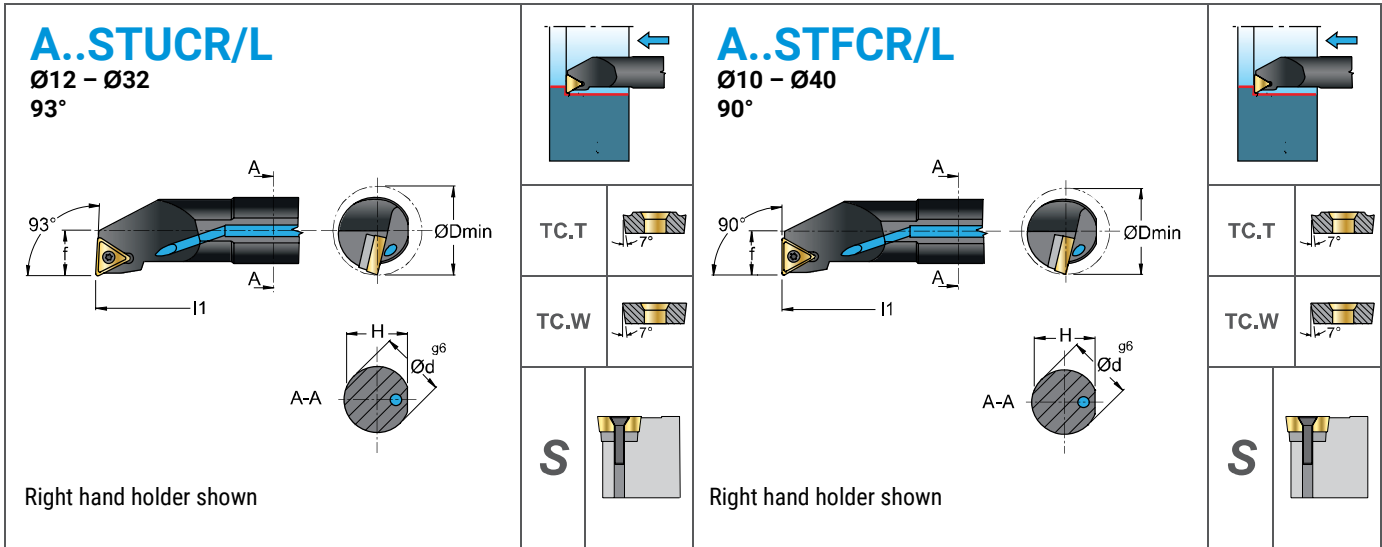

| Ordering Code         | L<br>R  | mm    |    |    |    |       | Nm  | °       | ①    | ②    | ③    | ④         |       |
|-----------------------|---------|-------|----|----|----|-------|-----|---------|------|------|------|-----------|-------|
|                       |         | ØDmin | Ød | f  | H  | l1    |     |         |      |      |      |           |       |
| A12K                  | STUCR/L | 11    | 16 | 12 | 9  | 11,50 | 125 | 1,1÷1,3 | 1102 | -    | -    | 12256P    | 5508P |
| A16M                  | STUCR/L | 16    | 20 | 16 | 11 | 15,25 | 150 | 3,8÷5,0 | 16T3 | -    | -    | 12409P    | 5515P |
| A20Q                  | STUCR/L | 16    | 25 | 20 | 13 | 19,00 | 180 | 3,8÷5,0 | 16T3 | -    | -    | 1240P     | 5515P |
| A25R                  | STUCR/L | 16    | 32 | 25 | 17 | 24,00 | 200 | 3,8÷5,0 | 16T3 | -    | -    | 1240P     | 5515P |
| A32S                  | STUCR/L | 16    | 40 | 32 | 22 | 31,00 | 250 | 3,0÷3,5 | 16T3 | 3415 | BCL7 | 123511P   | 5515P |
| A10H                  | STFCR/L | 09    | 12 | 10 | 7  | 9,50  | 100 | 0,9÷1,0 | 0902 | -    | -    | 12225P    | 5507P |
| A10H                  | STFCR/L | 11    | 12 | 10 | 7  | 9,50  | 100 | 1,1÷1,3 | 1102 | -    | -    | 12256P    | 5508P |
| A12K                  | STFCR/L | 11    | 16 | 12 | 9  | 11,50 | 125 | 1,1÷1,3 | 1102 | -    | -    | 12256P    | 5508P |
| A16M                  | STFCR/L | 11    | 20 | 16 | 11 | 15,25 | 150 | 1,1÷1,3 | 1102 | -    | -    | 12256P    | 5508P |
| A16M                  | STFCR/L | 16    | 20 | 16 | 11 | 15,25 | 150 | 3,8÷5,0 | 16T3 | -    | -    | 12409P    | 5515P |
| A20Q                  | STFCR/L | 16    | 25 | 20 | 13 | 19,00 | 180 | 3,8÷5,0 | 16T3 | -    | -    | 1240P     | 5515P |
| A25R                  | STFCR/L | 16    | 32 | 25 | 17 | 24,00 | 200 | 3,8÷5,0 | 16T3 | -    | -    | 1240P     | 5515P |
| A32S                  | STFCR/L | 16    | 40 | 32 | 22 | 31,00 | 250 | 3,0÷3,5 | 16T3 | 3415 | BCL7 | 123511P   | 5515P |
| A40T                  | STFCR/L | 16    | 50 | 40 | 27 | 38,50 | 300 | 3,0÷3,5 | 16T3 | 3415 | BCL7 | 123511P   | 5515P |
| <b>HSS toolholder</b> |         |       |    |    |    |       |     |         |      |      |      |           |       |
| AH08K                 | STFCR/L | 09    | 10 | 8  | 6  | 7.0   | 125 | 0,9÷1,0 | 0902 | -    | -    | BFTX02506 | TRX08 |
| AH10K                 | STFCR/L | 11    | 12 | 10 | 7  | 9.0   | 125 | 1,1÷1,3 | 1102 | -    | -    | BFTX02506 | TRX08 |
| AH12M                 | STFCR/L | 11    | 14 | 12 | 9  | 11.0  | 150 | 1,1÷1,3 | 1102 | -    | -    | BFTX02506 | TRX08 |
| AH16Q                 | STFCR/L | 11    | 18 | 16 | 11 | 14.0  | 180 | 1,1÷1,3 | 1102 | -    | -    | BFTX02506 | TRX08 |
| AH20R                 | STFCR/L | 11    | 23 | 20 | 13 | 18.0  | 200 | 1,1÷1,3 | 1102 | -    | -    | BFTX02506 | TRX08 |
| AH25R                 | STFCR/L | 16    | 28 | 25 | 17 | 23.0  | 200 | 3,8÷5,0 | 16T3 | -    | -    | BFTX0407  | TRX15 |
| AH25S                 | STFCR/L | 16    | 28 | 25 | 17 | 23.0  | 250 | 3,8÷5,0 | 16T3 | -    | -    | BFTX0407  | TRX15 |

Order example:  
Right hand A12K STUCR 11  
Left hand A12K STUCL 11

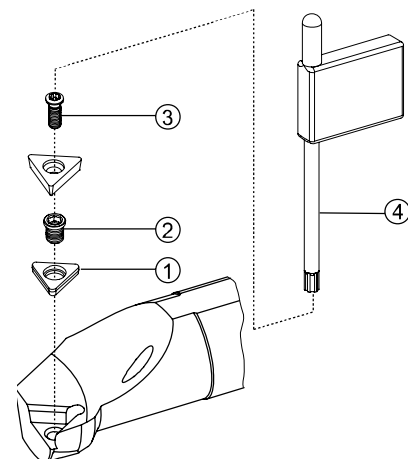

**E..STFCR/L**  
Ø10 – Ø20  
90°

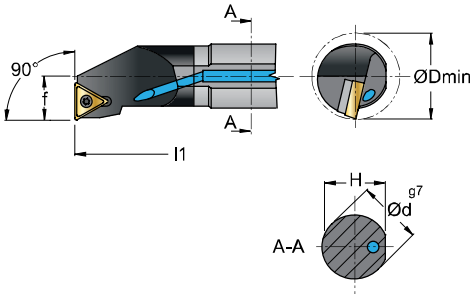

Right hand holder shown  
Carbide toolholder

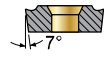
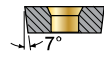
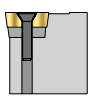
|      |   |
|------|---|
| TC.T |  |
| TC.W |  |
| S    |  |

| Ordering Code |  | mm    |    |    |       |     | <br>Nm |  | ①<br> | ②<br> |
|---------------|---|-------|----|----|-------|-----|---|--|--|--|
|               |   | ØDmin | Ød | f  | H     | l1  |   |  |  |  |
| E10K          | STFCR/L 09  | 13    | 10 | 7  | 9,50  | 150 | 0,9÷1,0   | 0902   | 12225P   | 5507P  |
| E12Q          | STFCR/L 11  | 16    | 12 | 9  | 11,50 | 180 | 1,1÷1,3   | 1102   | 12256P   | 5508P  |
| E16R          | STFCR/L 11  | 20    | 16 | 11 | 15,25 | 200 | 1,1÷1,3   |  |  |  |
| E20S          | STFCR/L 16  | 25    | 20 | 13 | 19,00 | 250 | 3,8÷5,0   | 16T3   | 1240P  | 5515P  |

Order example:  
Right hand E10K STFCR 09  
Left hand E10K STFCL 09

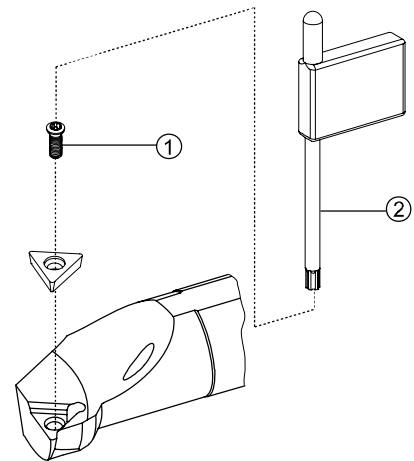

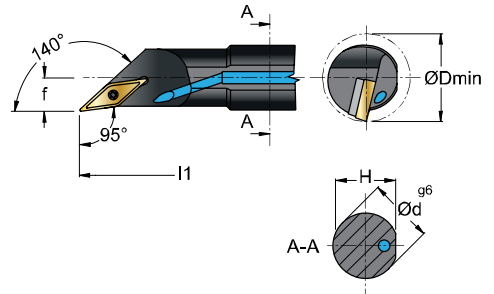

**A..SVOCR/L**  
Ø12 – Ø25  
140°

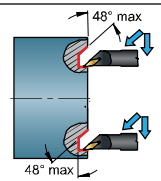
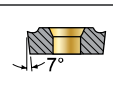
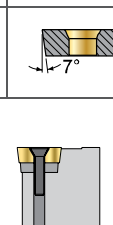
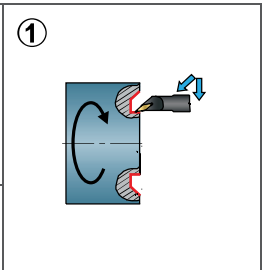
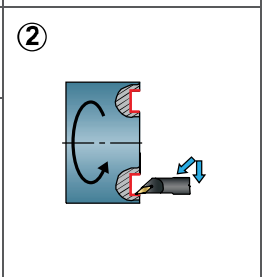

Right hand holder shown



|   |   |   |   |
|---|---|---|---|
|  |  |  |  |
| VC.T  | VC.W  | S   |  |

| Ordering Code |  | mm    |    |      |      |     | <br>Nm |  | ① | ② | ③       | ④     |
|---------------|---|-------|----|------|------|-----|---|---|---|---|---------|-------|
|               |   | ØDmin | Ød | f    | H    | l1  |   |   |   |   |         |       |
| A12K          | SVOCR/L 11  | 16    | 12 | 9    | 11,5 | 125 | 1,1÷1,3   | 1103  | - | - | 12256P  | 5508P |
| A16M          | SVOCR/L 11  | 20    | 16 | 11   | 15   | 150 | 1,1÷1,3   |   |   |   |         |       |
| A20Q          | SVOCR/L 16  | 23    | 20 | 12,5 | 19   | 180 | 3,0÷3,5   | 1604  | - | - | 123509P | 5515P |
| A25R          | SVOCR/L 16  | 30    | 25 | 16,5 | 24   | 200 | 3,0÷3,5   |   |   |   |         |       |

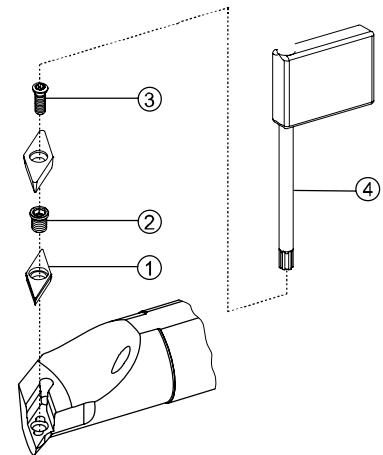
Order example:  
Right hand A12K SVOCR 11  
Left hand A12K SVOCL 11

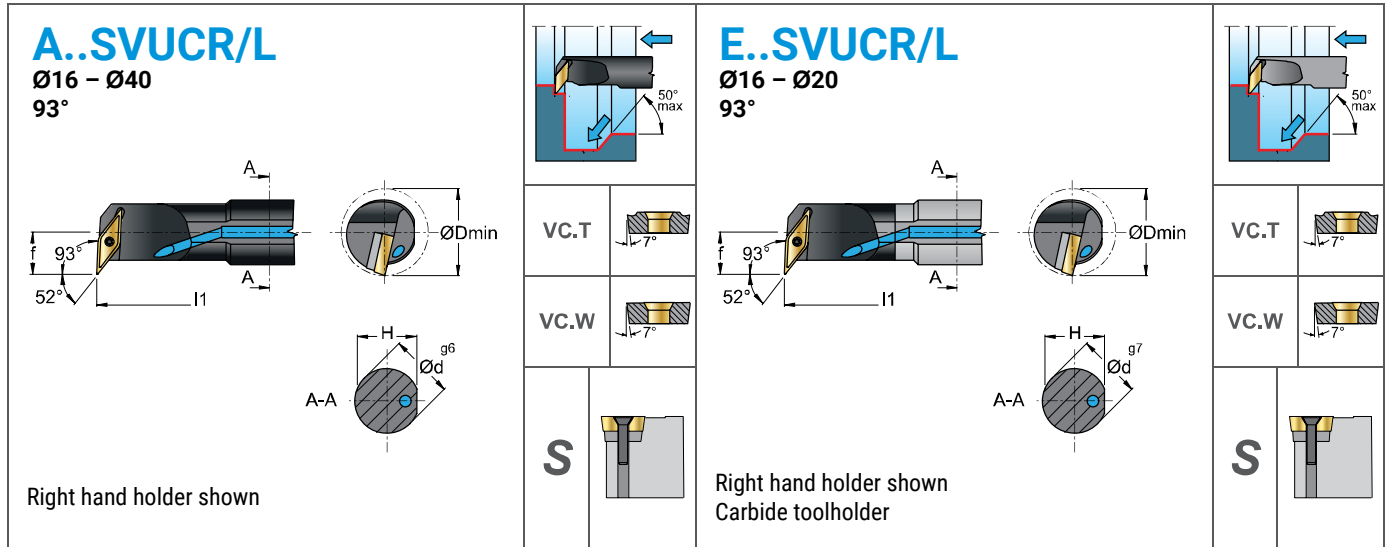





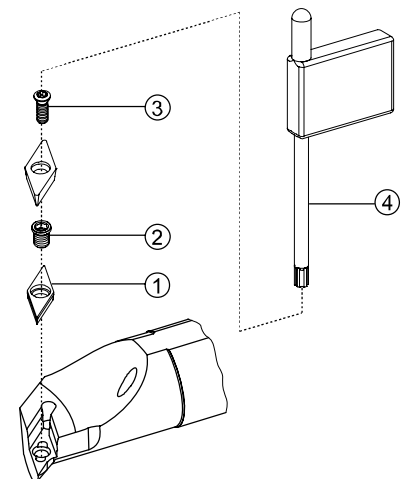

| Ordering Code |  |    | mm    |    |    |       |     | <br>Nm |  | ①    | ②    | ③       | ④     |
|---------------|---|----|-------|----|----|-------|-----|---|---|------|------|---------|-------|
|               |   |    | ØDmin | Ød | f  | H     | l1  |   |   |      |      |         |       |
| A16M          | SVUCR/L   | 11 | 21    | 16 | 12 | 15,25 | 150 | 1,1÷1,3   | 1103  | -    | -    | 12256P  | 5508P |
| A20Q          | SVUCR/L   | 11 | 25    | 20 | 13 | 19,00 | 180 | 1,1÷1,3   |   |      |      |         |       |
| A25R          | SVUCR/L   | 16 | 32    | 25 | 17 | 24,00 | 200 | 3,0÷3,5   | 1604  | -    | -    | 123509P | 5515P |
| A32S          | SVUCR/L   | 16 | 40    | 32 | 22 | 31,00 | 250 | 3,0÷3,5   | 1604  | 3716 | BCL7 | 123511P | 5515P |
| A40T          | SVUCR/L   | 16 | 50    | 40 | 27 | 38,50 | 300 | 3,0÷3,5   |   |      |      |         |       |
| E16R          | SVUCR/L   | 11 | 21    | 16 | 11 | 15,25 | 200 | 1,1÷1,3   | 1103  | -    | -    | 12256P  | 5508P |
| E20S          | SVUCR/L   | 11 | 25    | 20 | 13 | 19,00 | 250 | 1,1÷1,3   |   |      |      |         |       |

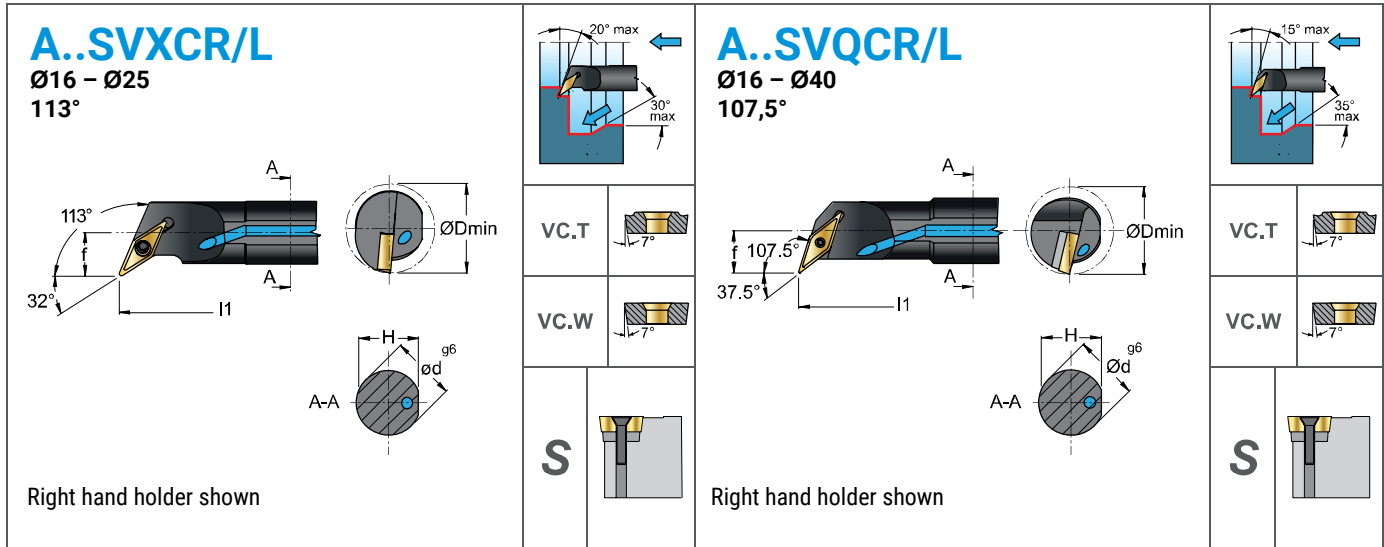
Order example:  
Right hand A16M SVUCR 11  
Left hand A16M SVUCL 11





| Ordering Code |  | Артикул | mm    |    |    |       |     |         | <br>Nm |  | ① | ②      | ③       | ④     |
|---------------|---|---------|-------|----|----|-------|-----|---------|---|--|---|--------|---------|-------|
|               |   |         | ØDmin | Ød | f  | H     | l1  |         |   |  |   |        |         |       |
| A16M          | SVXCR/L 11  | 1220120 | 20    | 16 | 11 | 15,25 | 150 | 1,1÷1,3 | 1103  | -  | - | 12256P | 5508P   |       |
| A20Q          | SVXCR/L 11  | 1220121 | 25    | 20 | 13 | 19,00 | 180 | 1,1÷1,3 |   | -  | - | 12256P | 5508P   |       |
| A25R          | SVXCR/L 16  | 1220122 | 32    | 25 | 17 | 24,00 | 200 | 3,0÷3,5 |   | 1604   | - | -      | 123509P | 5515P |

|      |            |         |    |    |    |       |     |         |      |      |      |         |         |
|------|------------|---------|----|----|----|-------|-----|---------|------|------|------|---------|---------|
| A16M | SVQCR/L 11 | 1220123 | 20 | 16 | 11 | 15,25 | 150 | 1,1÷1,3 | 1103 | -    | -    | 12256P  | 5508P   |
| A20Q | SVQCR/L 11 | 1220124 | 25 | 20 | 13 | 19,00 | 180 | 1,1÷1,3 |      | -    | -    | 12256P  | 5508P   |
| A25R | SVQCR/L 16 | 1220125 | 32 | 25 | 17 | 24,00 | 200 | 3,0÷3,5 |      | 1604 | -    | -       | 123509P |
| A32S | SVQCR/L 16 | 1220126 | 40 | 32 | 22 | 31,00 | 250 | 3,0÷3,5 | 1604 | 3716 | BCL7 | 123511P | 5515P   |
| A40T | SVQCR/L 16 | 1220127 | 50 | 40 | 27 | 38,50 | 300 | 3,0÷3,5 |      | -    | -    | -       | -       |

Order example:  
Right hand A16M SVXCR 11  
Left hand A16M SVXCL 11

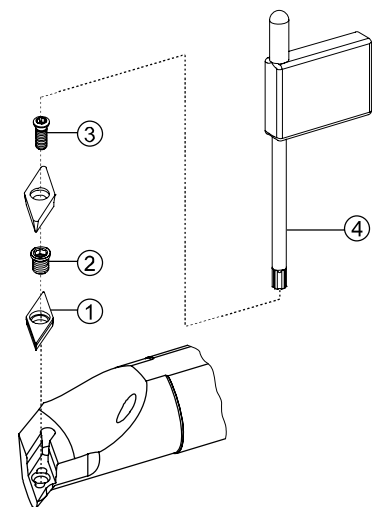

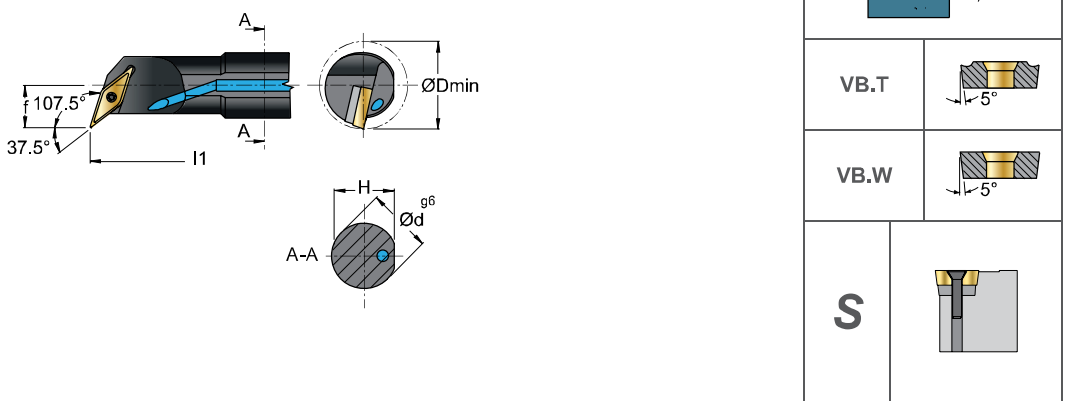

**A..SVQBR/L**  
Ø25 – Ø40  
107,5°

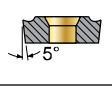
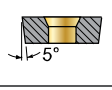
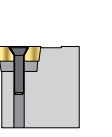

Right hand holder shown

|      |   |
|------|---|
| VB.T |  |
| VB.W |  |
| S    |  |

| Ordering Code |  | Артикул | mm    |    |    |      |     | <br>Nm |  | ①    | ②    | ③       | ④     |
|---------------|---|---------|-------|----|----|------|-----|---|---|------|------|---------|-------|
|               |   |         | ØDmin | Ød | f  | H    | l1  |   |   |      |      |         |       |
| A25R          | SVQBR/L 16  | 1220128 | 32    | 25 | 17 | 24,0 | 200 | 3,0÷3,5   | 1604  | -    | -    | 123509P | 5515P |
| A32S          | SVQBR/L 16  | 1220129 | 40    | 32 | 22 | 31,0 | 250 | 3,0÷3,5   | 1604  | 3716 | BCL7 | 123511P | 5515P |
| A40T          | SVQBR/L 16  | 1220130 | 50    | 40 | 27 | 38,5 | 300 | 3,0÷3,5   |   |      |      |         |       |

Order example:  
Right hand A25R SVQBR 16  
Left hand A25R SVQBL 16

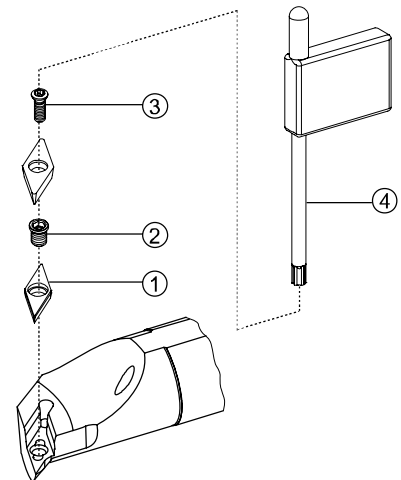





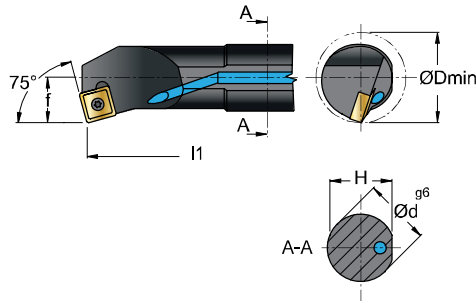

**A..SSKCR/L**

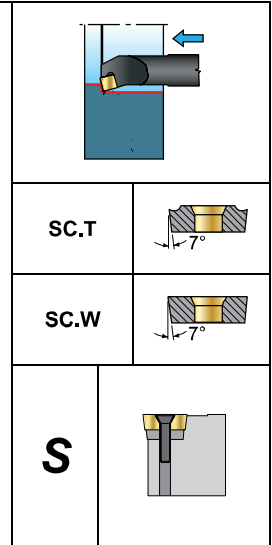
Ø16 – Ø25  
75°



Right hand holder shown



| Ordering Code |  | mm    |    |    |       |     | <br>Nm |  | ①<br> | ②<br> |
|---------------|---|-------|----|----|-------|-----|---|--|--|--|
|               |   | ØDmin | Ød | f  | H     | l1  |   |  |  |  |
| A16M          | SSKCR/L 09  | 20    | 16 | 11 | 15,25 | 150 | 3,8÷5,0   | 09T3   | 12409P   | 5515P  |
| A20Q          | SSKCR/L 09  | 25    | 20 | 13 | 19,00 | 180 | 3,8÷5,0   | 09T3   | 12409P   | 5515P  |
| A25R          | SSKCR/L 12  | 32    | 25 | 17 | 24,00 | 200 | 4,0÷5,0   | 1204   | 124510   | 5520   |

Order example:  
Right hand A16M SSKCR 09  
Left hand A16M SSKCL 09

